











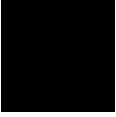





CONFLUENCE
Updated 5/1/18
Pricing effective 6/1/18



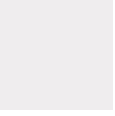

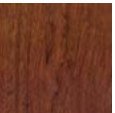

DeskMakers

| <u>Table of Contents</u> | <u>Page</u> |
|--------------------------|-------------|
| Laminates | 4 |
| Product Details | 5-11 |
| Grade 1 Tables | 12-13 |
| Grade 2 Tables | 14-15 |
| Grade 3 Tables | 16-17 |
| Grade 4 Tables | 18-19 |
| Terms and Conditions | 20 |
| Warranty | 21 |

Standard Thermofuse Laminate Finishes (TFL)

| | | | |
|---|--|--|---|
|  Black Matching Matte HPL: Arborite AAS405CAP |  Dove Grey Matching Matte HPL: Wilsonart D92-60 |  Mahogany Matching Matte HPL: Wilsonart 7122T-60 |  Tenino Grey Matching Matte HPL: Limited availability; call customer service |
|  Black Forest Walnut Matching Matte HPL: Pionite WX421 Witchcraft <i>*Not an exact match</i> |  Gunmetal Grey Matching Matte HPL: Nevamar S6-20-T |  Oil Cherry Matching Matte HPL: Pionite WC421-S |  Tuscan Walnut Matching Matte HPL: Arborite AAW-444-FPP |
|  Café Latte* Matching Matte HPL: Not Available |  Hardrock Maple Matching Matte HPL: Formica 86992-58 |  Regal White Matching Matte HPL: Arborite 550 Elegant White |  Yorkshire Cherry Matching Matte HPL: Pionite WC411-N |
|  Cognac Matching Matte HPL: Pionite HP336N Sunset |  Iconic Maple Matching Matte HPL: Nevamar WM0047-T <i>*Not an exact match</i> |  Spice Walnut Matching Matte HPL: Pionite WW561-N | |

Premium Textured Thermofuse Laminate Finishes (TFL)

| | | | |
|--|--|---|--|
|  Intrigue* Matching Matte HPL: Limited availability; call customer service |  Iron Hemlock Matching Matte HPL: Pionite W163-OZ Looks Likatre |  Loft Matching Matte HPL: Limited availability; call customer service |  Natural Ash* Matching Matte HPL: Formica 8842-WR |
|  Nightfall Matching Matte HPL: Pionite W292-OZ |  Rustic Oak* <i>*Supermatte Texture</i> Matching Matte HPL: Not Available |  Silverwood* Matching Matte HPL: Limited availability; call customer service | |

Premium textured TFLs require a 10% upcharge. Add item code OP-TTFL-1.

Matching 2MM PVC edgebanding is available for all Standard and Premium TFL finishes shown here.

*Not available in one piece tops over 96" long.

High-Pressure Laminate Finishes (HPL)

Pricing shown in this price list applies only to non-premium HPL's as follows:

- Wilsonart: Solids, Woodgrains, and Abstracts in Matte (-60) finish,
- Formica: Color Portfolio, Woodgrains, and Patterns in Matte (-58) finish
- Pionite: Solids, Woodgrains, and Abstracts in Suede (N) finish

Call customer service for pricing for all other HPLs from the above companies, or for pricing for HPL from Arborite and Nevamar.

Additional lead times required for HPL orders depending on material availability and order complexity.

Due to engineering, HPL must be combined with a standard 2MM DeskMakers PVC edgebanding. Self-edge, thin PVC, or 3MM PVC are not available.

Table Styles

Grade 1 Tables



Desk Height



Standing Height

- 1-1/8" thick panels
- All panels are TFL or HPL
- Deskmakers standard 2MM PVC edge banding
- Top over end panel construction
- 12" high dual stretchers on desk height tables
- 18" high dual stretchers on standing height tables
- Adjustable levelers
- Ships unassembled
- Tables over 96" available in Southern California and/or will call only

Grade 2 Tables



Desk Height

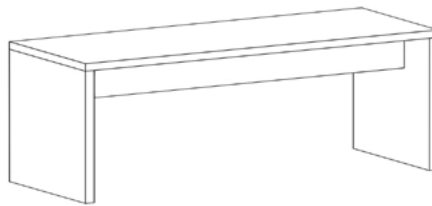

Standing Height

- 1-7/8" thick panels
- Deskmakers standard 2MM PVC edge banding
- Top over end panel construction
- 6" high dual stretchers on desk height tables
- 12" high dual stretchers on standing height tables
- Adjustable levelers
- Ships unassembled
- Tables over 96" available in Southern California and/or will call only

Grade 3 Tables



Desk Height



Standing Height

- 3" thick panels
- All panels HPL; TFL not available
- HPL self edge
- Mitered corner construction
- Recessed metal support rods
- Optional removable access door
- Adjustable levelers
- Ships assembled
- Tables over 96" available in Southern California and/or will call only

Grade 4 Tables



Desk Height



Standing Height

- 3-3/8" thick panels
- All panels HPL; TFL not available
- Deskmakers standard 2MM PVC edge banding
- Recessed middle accent color stripe
- Mitered corner construction
- Recessed metal support rods
- Optional removable access door
- Adjustable levelers
- Ships assembled
- Tables over 96" available in Southern California and/or will call only

Confluence Table Finishes and Grain Direction

Grade 1 Tables

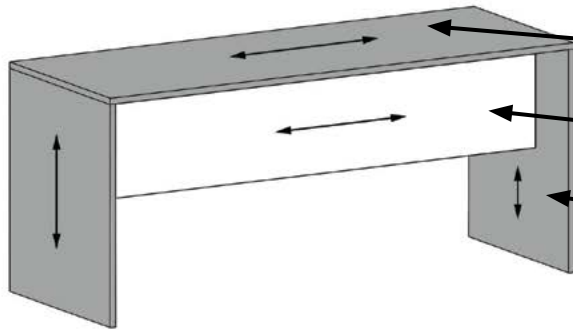

- Table Top Finish: Primary Color
- 2MM PVC Edge Finish: Deskmakers Standard Matching Color
- Support Beam Finish: Primary or Secondary Color
- 2MM PVC Edge Finish: Deskmakers Standard Matching Color
- Base Finish (both sides): Primary or Secondary Color
- 2MM PVC Edge Finish: Deskmakers Standard Matching Color

Grade 2 Tables

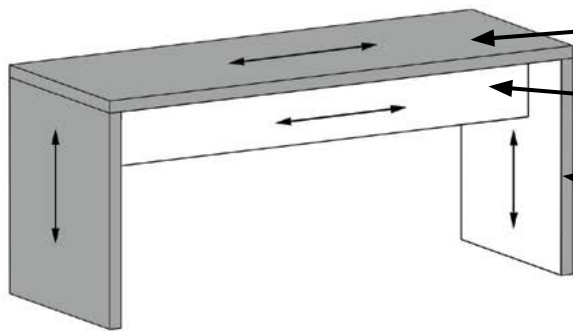

- Table Top Finish: Primary Color
- 2MM PVC Edge Finish: Deskmakers Standard Matching Color
- Support Beam Finish: Primary or Secondary Color
- 2MM PVC Edge Finish: Deskmakers Standard Matching Color
- Base Finish: Primary Color
- 2MM PVC Edge Finish: Deskmakers Standard Matching Color

Grade 3 Tables

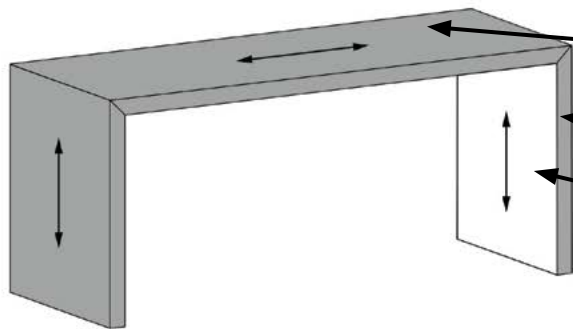

- Table Top Finish: Primary Color
- HPL Self Edge Finish: Matching Primary Color
- Outer Base Finish: Primary Color
- HPL Self Edge Finish: Primary or Secondary Color
- Inner Base Finish: Primary or Secondary Color

Grade 4 Tables

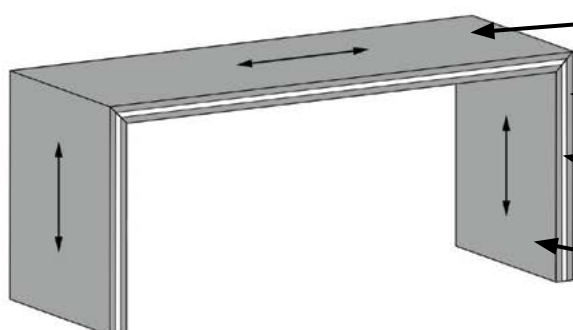

- Table Top Finish: Primary Color
- 2MM PVC Edge Finish: Deskmakers Standard Matching Color
- Outer Base Finish: Primary Color
- 2MM PVC Edge Finish: Deskmakers Standard Matching Color
- Recessed Middle Stripe Finish: Secondary Color
- 2MM PVC Edge Finish: Deskmakers Standard Matching Color
- Inner Panel Finishes: Primary Color
- 2MM PVC Edge Finish: Deskmakers Standard Matching Color

Grade 1 And Grade 2 Wiring

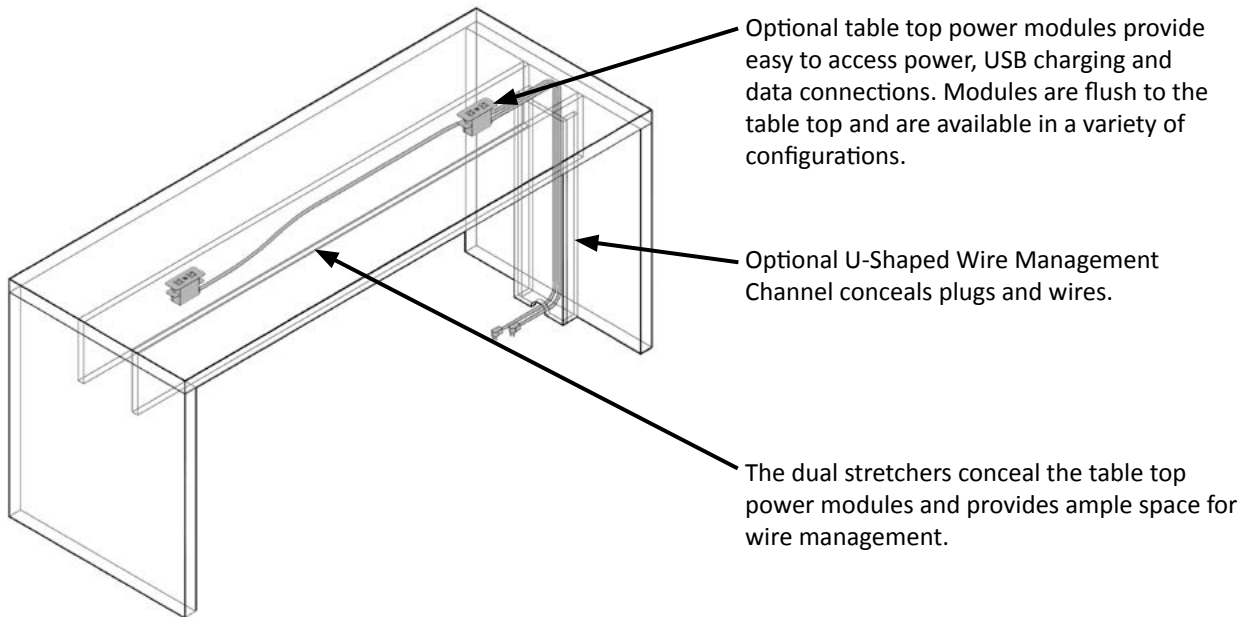

Grade 3 And Grade 4 Wiring

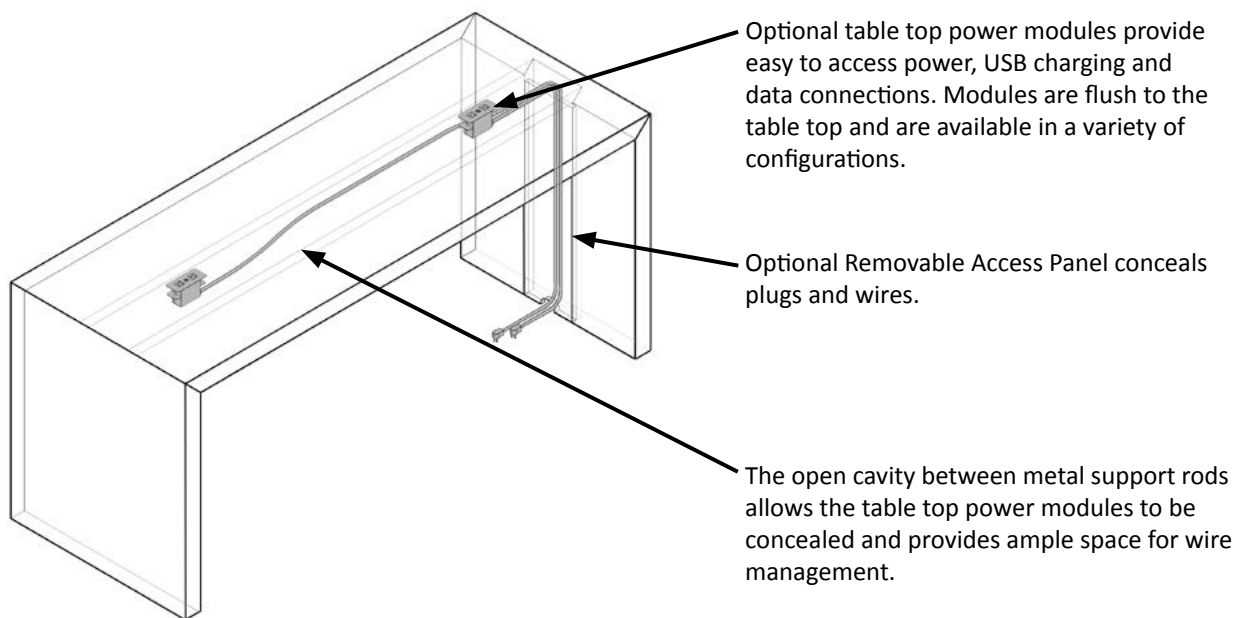

Power Locations

Single Power Unit

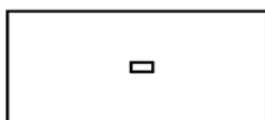

For all sizes

Power unit is centered on both the length and width.

Double Power Unit

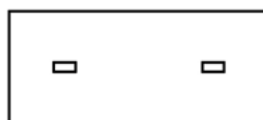

For all sizes

Power units are 18" on center from ends and centered on the width.

Triple Power Unit

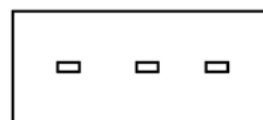

For tables above 96" only

End power units are 18" on center from ends and centered on the width. Middle power unit is centered on both the length and width.

Surface Mounted Power

AC-ELCV-06, AC-ELCV-07, AC-ELCV-08

See Electrical Pricebook Page 27 for pricing



Specifications

- Multiple configurations available
- Spill resistant power outlets
- (1) 108" long 15amp plug cord
- Clamp mount
- Available finishes: Black, Silver and White

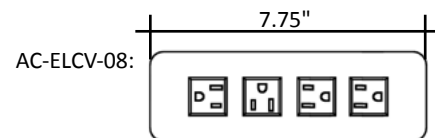
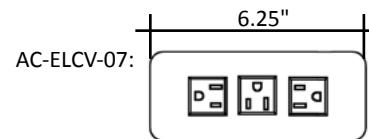
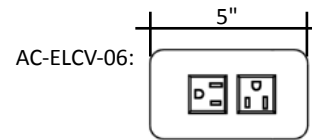
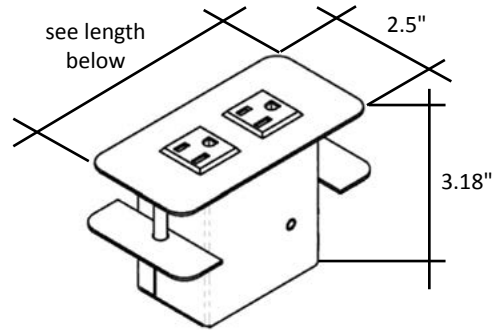

Surface Mounted Power and USB Unit

AC-ELCV-01, AC-ELCV-02, AC-ELCV-03, AC-ELCV-04

See Electrical Pricebook Page 28 for pricing



Specifications

- Multiple configurations available
- Spill resistant power outlets
- (2) 2.1A USB charging ports
- (1) 108" long 15amp plug cord
- Clamp mount
- Available finishes: Black, Silver and White

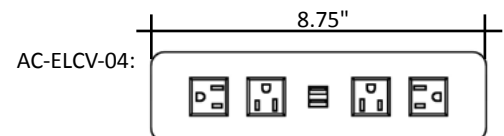
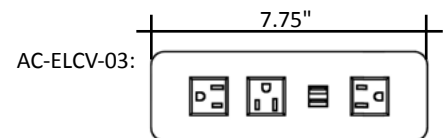
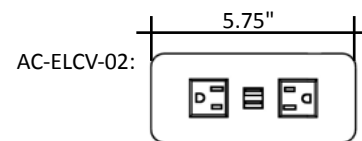
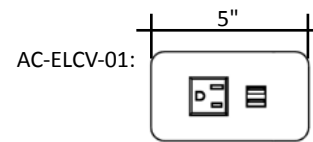
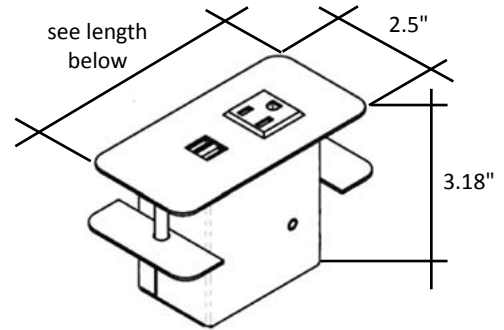

Surface Mounted Power with USB and Data

AC-ELCV-09, AC-ELCV-10, AC-ELCV-11

See Electrical Pricebook Page 29 for pricing



(image shown with interface plate - not included)

Specifications

- Multiple configurations available
- Spill resistant power outlets
- (2) 2.1A USB charging ports
- (1) cutout for interface plate (not included)
- (1) 108" long 15amp plug cord
- Clamp mount
- Available finishes: Black, Silver and White

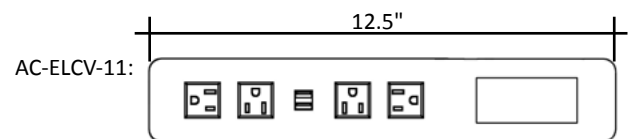
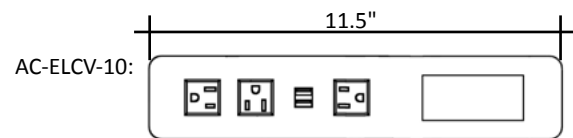
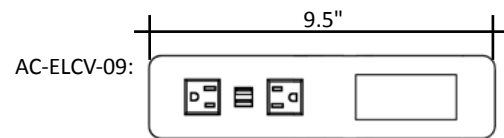
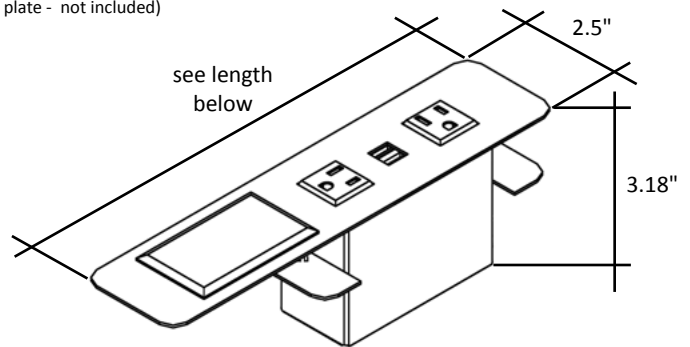

Cordless Charging Unit

AC-ELAC-01, AC-ELAC-02

See Electrical Pricebook Page 31 for pricing



Specifications

- Cordless charging capability
- Compatibility with all Qi rated devices and smartphones*
- Fits into 3.14" grommet cutout
- (1) 78" long 15amp cord with USB end
- Steel mounting plate
- Available finishes: Black and White with Aluminum Trim

**For complete list of compatible devices, contact customer service.*

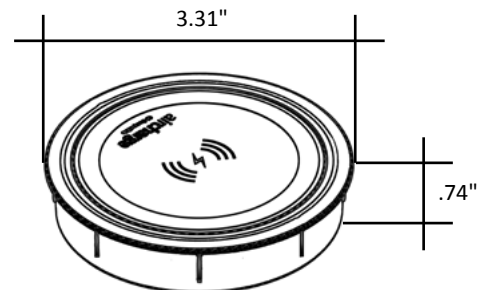

Orb Wireless Receiver



Optional orb wireless receiver allows devices not equipped with the Qi technology to be used with charging unit. To use, connect the receiver to device and place receiver on charging unit. Orb wireless receiver includes Lightning, 30-pin and Micro-USB connectors.



Grade 1

Desk Height Parsons Table



- 1-1/8" thick panels
- All panels are TFL or HPL
- Deskmakers 2MM PVC edge banding, HPL self edge not available
- Top over end panel construction
- 12" high dual support beams
- Ships unassembled
- Tables over 96" available in Southern California and/or will call only

| Model Number | Width | Length | Height | TFL (T) | HPL (H) |
|-----------------|-------|--------|--------|---------|---------|
| 30" Wide | | | | | |
| CN-GR1D-3060-? | 30 | 60 | 29 | \$864 | \$1,297 |
| CN-GR1D-3066-? | 30 | 66 | 29 | \$896 | \$1,345 |
| CN-GR1D-3072-? | 30 | 72 | 29 | \$929 | \$1,394 |
| CN-GR1D-3078-? | 30 | 78 | 29 | \$961 | \$1,441 |
| CN-GR1D-3084-? | 30 | 84 | 29 | \$994 | \$1,491 |
| CN-GR1D-3090-? | 30 | 90 | 29 | \$1,130 | \$1,696 |
| CN-GR1D-3096-? | 30 | 96 | 29 | \$1,163 | \$1,744 |
| CN-GR1D-3002-? | 30 | 102 | 29 | \$1,195 | \$1,793 |
| CN-GR1D-3008-? | 30 | 108 | 29 | \$1,228 | \$1,843 |
| CN-GR1D-3014-? | 30 | 114 | 29 | \$1,260 | \$1,891 |
| CN-GR1D-3020-? | 30 | 120 | 29 | \$1,293 | \$1,940 |
| 36" Wide | | | | | |
| CN-GR1D-3660-? | 36 | 60 | 29 | \$976 | \$1,463 |
| CN-GR1D-3666-? | 36 | 66 | 29 | \$1,015 | \$1,523 |
| CN-GR1D-3672-? | 36 | 72 | 29 | \$1,054 | \$1,581 |
| CN-GR1D-3678-? | 36 | 78 | 29 | \$1,093 | \$1,640 |
| CN-GR1D-3684-? | 36 | 84 | 29 | \$1,132 | \$1,697 |
| CN-GR1D-3690-? | 36 | 90 | 29 | \$1,275 | \$1,913 |
| CN-GR1D-3696-? | 36 | 96 | 29 | \$1,314 | \$1,971 |
| CN-GR1D-3602-? | 36 | 102 | 29 | \$1,353 | \$2,030 |
| CN-GR1D-3608-? | 36 | 108 | 29 | \$1,392 | \$2,087 |
| CN-GR1D-3614-? | 36 | 114 | 29 | \$1,431 | \$2,147 |
| CN-GR1D-3620-? | 36 | 120 | 29 | \$1,471 | \$2,206 |
| 42" Wide | | | | | |
| CN-GR1D-4260-? | 42 | 60 | 29 | \$1,088 | \$1,632 |
| CN-GR1D-4266-? | 42 | 66 | 29 | \$1,133 | \$1,699 |
| CN-GR1D-4272-? | 42 | 72 | 29 | \$1,178 | \$1,768 |
| CN-GR1D-4278-? | 42 | 78 | 29 | \$1,224 | \$1,837 |
| CN-GR1D-4284-? | 42 | 84 | 29 | \$1,270 | \$1,905 |
| CN-GR1D-4290-? | 42 | 90 | 29 | \$1,419 | \$2,128 |
| CN-GR1D-4296-? | 42 | 96 | 29 | \$1,464 | \$2,196 |
| CN-GR1D-4202-? | 42 | 102 | 29 | \$1,510 | \$2,265 |
| CN-GR1D-4208-? | 42 | 108 | 29 | \$1,556 | \$2,334 |
| CN-GR1D-4214-? | 42 | 114 | 29 | \$1,601 | \$2,401 |
| CN-GR1D-4220-? | 42 | 120 | 29 | \$1,646 | \$2,470 |

U-Shaped Wire Management Channel



| Model Number | Depth | Width | Height | Price |
|--------------|-------|-------|--------|-------|
| CN-UCHN-29 | 3 | 10 | 24 | \$200 |

- 3/4" thermofuse laminate material only. Ships with mounting hardware for securing to table base.

Grade 1

Standing Height Parsons Table

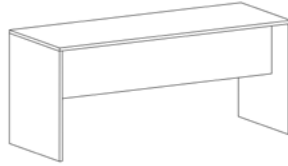

- 1-1/8" thick panels
- All panels are TFL or HPL
- Deskmakers 2MM PVC edge banding, HPL self edge not available
- Top over end panel construction
- 18" high dual support beams
- Ships unassembled
- Tables over 96" available in Southern California and/or will call only

| Model Number | Width | Length | Height | TFL (T) | HPL (H) |
|-----------------|-------|--------|--------|---------|---------|
| 30" Wide | | | | | |
| CN-GR1S-3060-? | 30 | 60 | 42 | \$919 | \$1,379 |
| CN-GR1S-3066-? | 30 | 66 | 42 | \$952 | \$1,428 |
| CN-GR1S-3072-? | 30 | 72 | 42 | \$984 | \$1,476 |
| CN-GR1S-3078-? | 30 | 78 | 42 | \$1,016 | \$1,525 |
| CN-GR1S-3084-? | 30 | 84 | 42 | \$1,049 | \$1,575 |
| CN-GR1S-3090-? | 30 | 90 | 42 | \$1,186 | \$1,778 |
| CN-GR1S-3096-? | 30 | 96 | 42 | \$1,218 | \$1,827 |
| CN-GR1S-3002-? | 30 | 102 | 42 | \$1,250 | \$1,875 |
| CN-GR1S-3008-? | 30 | 108 | 42 | \$1,283 | \$1,925 |
| CN-GR1S-3014-? | 30 | 114 | 42 | \$1,316 | \$1,974 |
| CN-GR1S-3020-? | 30 | 120 | 42 | \$1,348 | \$2,022 |
| 36" Wide | | | | | |
| CN-GR1S-3660-? | 36 | 60 | 42 | \$1,040 | \$1,560 |
| CN-GR1S-3666-? | 36 | 66 | 42 | \$1,080 | \$1,619 |
| CN-GR1S-3672-? | 36 | 72 | 42 | \$1,118 | \$1,678 |
| CN-GR1S-3678-? | 36 | 78 | 42 | \$1,158 | \$1,737 |
| CN-GR1S-3684-? | 36 | 84 | 42 | \$1,196 | \$1,794 |
| CN-GR1S-3690-? | 36 | 90 | 42 | \$1,340 | \$2,009 |
| CN-GR1S-3696-? | 36 | 96 | 42 | \$1,378 | \$2,068 |
| CN-GR1S-3602-? | 36 | 102 | 42 | \$1,418 | \$2,127 |
| CN-GR1S-3608-? | 36 | 108 | 42 | \$1,456 | \$2,184 |
| CN-GR1S-3614-? | 36 | 114 | 42 | \$1,496 | \$2,243 |
| CN-GR1S-3620-? | 36 | 120 | 42 | \$1,534 | \$2,302 |
| 42" Wide | | | | | |
| CN-GR1S-4260-? | 42 | 60 | 42 | \$1,162 | \$1,743 |
| CN-GR1S-4266-? | 42 | 66 | 42 | \$1,206 | \$1,810 |
| CN-GR1S-4272-? | 42 | 72 | 42 | \$1,252 | \$1,878 |
| CN-GR1S-4278-? | 42 | 78 | 42 | \$1,298 | \$1,947 |
| CN-GR1S-4284-? | 42 | 84 | 42 | \$1,344 | \$2,016 |
| CN-GR1S-4290-? | 42 | 90 | 42 | \$1,492 | \$2,239 |
| CN-GR1S-4296-? | 42 | 96 | 42 | \$1,538 | \$2,308 |
| CN-GR1S-4202-? | 42 | 102 | 42 | \$1,584 | \$2,376 |
| CN-GR1S-4208-? | 42 | 108 | 42 | \$1,630 | \$2,445 |
| CN-GR1S-4214-? | 42 | 114 | 42 | \$1,674 | \$2,512 |
| CN-GR1S-4220-? | 42 | 120 | 42 | \$1,720 | \$2,580 |

U-Shaped Wire Management Channel



| Model Number | Depth | Width | Height | Price |
|--------------|-------|-------|--------|-------|
| CN-UCHN-42 | 3 | 10 | 36 | \$225 |

- 3/4" thermofuse laminate material only. Ships with mounting hardware for securing to table base.

Grade 2

Desk Height Parsons Table



- 1-7/8" thick panels
- Deskmakers 2MM PVC edge banding, HPL self edge not available
- Top over end panel construction
- 6" high dual support beams
- Ships unassembled
- Tables over 96" available in Southern California and/or will call only

| Model Number | Width | Length | Height | TFL (T) | HPL (H) |
|-----------------|-------|--------|--------|---------|---------|
| 30" Wide | | | | | |
| CN-GR2D-3060-? | 30 | 60 | 29 | \$2,061 | \$3,092 |
| CN-GR2D-3066-? | 30 | 66 | 29 | \$2,134 | \$3,201 |
| CN-GR2D-3072-? | 30 | 72 | 29 | \$2,207 | \$3,310 |
| CN-GR2D-3078-? | 30 | 78 | 29 | \$2,280 | \$3,420 |
| CN-GR2D-3084-? | 30 | 84 | 29 | \$2,355 | \$3,532 |
| CN-GR2D-3090-? | 30 | 90 | 29 | \$2,530 | \$3,796 |
| CN-GR2D-3096-? | 30 | 96 | 29 | \$2,603 | \$3,905 |
| CN-GR2D-3002-? | 30 | 102 | 29 | \$2,676 | \$4,014 |
| CN-GR2D-3008-? | 30 | 108 | 29 | \$2,751 | \$4,127 |
| CN-GR2D-3014-? | 30 | 114 | 29 | \$2,824 | \$4,234 |
| CN-GR2D-3020-? | 30 | 120 | 29 | \$2,895 | \$4,343 |
| 36" Wide | | | | | |
| CN-GR2D-3660-? | 36 | 60 | 29 | \$2,312 | \$3,468 |
| CN-GR2D-3666-? | 36 | 66 | 29 | \$2,401 | \$3,603 |
| CN-GR2D-3672-? | 36 | 72 | 29 | \$2,488 | \$3,732 |
| CN-GR2D-3678-? | 36 | 78 | 29 | \$2,576 | \$3,865 |
| CN-GR2D-3684-? | 36 | 84 | 29 | \$2,664 | \$3,997 |
| CN-GR2D-3690-? | 36 | 90 | 29 | \$2,856 | \$4,284 |
| CN-GR2D-3696-? | 36 | 96 | 29 | \$2,942 | \$4,414 |
| CN-GR2D-3602-? | 36 | 102 | 29 | \$3,032 | \$4,548 |
| CN-GR2D-3608-? | 36 | 108 | 29 | \$3,118 | \$4,677 |
| CN-GR2D-3614-? | 36 | 114 | 29 | \$3,207 | \$4,811 |
| CN-GR2D-3620-? | 36 | 120 | 29 | \$3,296 | \$4,944 |
| 42" Wide | | | | | |
| CN-GR2D-4260-? | 42 | 60 | 29 | \$2,565 | \$3,847 |
| CN-GR2D-4266-? | 42 | 66 | 29 | \$2,666 | \$3,999 |
| CN-GR2D-4272-? | 42 | 72 | 29 | \$2,768 | \$4,153 |
| CN-GR2D-4278-? | 42 | 78 | 29 | \$2,871 | \$4,308 |
| CN-GR2D-4284-? | 42 | 84 | 29 | \$2,974 | \$4,462 |
| CN-GR2D-4290-? | 42 | 90 | 29 | \$3,179 | \$4,769 |
| CN-GR2D-4296-? | 42 | 96 | 29 | \$3,282 | \$4,923 |
| CN-GR2D-4202-? | 42 | 102 | 29 | \$3,385 | \$5,078 |
| CN-GR2D-4208-? | 42 | 108 | 29 | \$3,488 | \$5,232 |
| CN-GR2D-4214-? | 42 | 114 | 29 | \$3,588 | \$5,382 |
| CN-GR2D-4220-? | 42 | 120 | 29 | \$3,691 | \$5,537 |

U-Shaped Wire Management Channel



| Model Number | Depth | Width | Height | Price |
|--------------|-------|-------|--------|-------|
| CN-UCHN-29 | 3 | 10 | 24 | \$200 |

- 3/4" thermofuse laminate material only. Ships with mounting hardware for securing to table base.

Grade 2

Standing Height Parsons Table

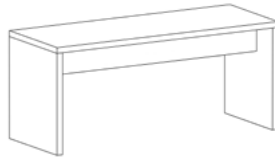

- 1-7/8" thick panels
- Deskmakers 2MM PVC edge banding, HPL self edge not available
- Top over end panel construction
- 12" high dual support beams
- Ships unassembled
- Tables over 96" available in Southern California and/or will call only

| Model Number | Width | Length | Height | TFL (T) | HPL (H) |
|-----------------|-------|--------|--------|---------|---------|
| 30" Wide | | | | | |
| CN-GR2S-3060-? | 30 | 60 | 42 | \$2,186 | \$3,279 |
| CN-GR2S-3066-? | 30 | 66 | 42 | \$2,258 | \$3,387 |
| CN-GR2S-3072-? | 30 | 72 | 42 | \$2,331 | \$3,496 |
| CN-GR2S-3078-? | 30 | 78 | 42 | \$2,403 | \$3,606 |
| CN-GR2S-3084-? | 30 | 84 | 42 | \$2,478 | \$3,718 |
| CN-GR2S-3090-? | 30 | 90 | 42 | \$2,655 | \$3,983 |
| CN-GR2S-3096-? | 30 | 96 | 42 | \$2,727 | \$4,090 |
| CN-GR2S-3002-? | 30 | 102 | 42 | \$2,800 | \$4,200 |
| CN-GR2S-3008-? | 30 | 108 | 42 | \$2,875 | \$4,312 |
| CN-GR2S-3014-? | 30 | 114 | 42 | \$2,947 | \$4,421 |
| CN-GR2S-3020-? | 30 | 120 | 42 | \$3,020 | \$4,530 |
| 36" Wide | | | | | |
| CN-GR2S-3660-? | 36 | 60 | 42 | \$2,458 | \$3,687 |
| CN-GR2S-3666-? | 36 | 66 | 42 | \$2,546 | \$3,819 |
| CN-GR2S-3672-? | 36 | 72 | 42 | \$2,632 | \$3,949 |
| CN-GR2S-3678-? | 36 | 78 | 42 | \$2,722 | \$4,083 |
| CN-GR2S-3684-? | 36 | 84 | 42 | \$2,808 | \$4,212 |
| CN-GR2S-3690-? | 36 | 90 | 42 | \$3,001 | \$4,502 |
| CN-GR2S-3696-? | 36 | 96 | 42 | \$3,088 | \$4,632 |
| CN-GR2S-3602-? | 36 | 102 | 42 | \$3,176 | \$4,764 |
| CN-GR2S-3608-? | 36 | 108 | 42 | \$3,264 | \$4,895 |
| CN-GR2S-3614-? | 36 | 114 | 42 | \$3,352 | \$5,028 |
| CN-GR2S-3620-? | 36 | 120 | 42 | \$3,438 | \$5,157 |
| 42" Wide | | | | | |
| CN-GR2S-4260-? | 42 | 60 | 42 | \$2,731 | \$4,097 |
| CN-GR2S-4266-? | 42 | 66 | 42 | \$2,832 | \$4,248 |
| CN-GR2S-4272-? | 42 | 72 | 42 | \$2,935 | \$4,402 |
| CN-GR2S-4278-? | 42 | 78 | 42 | \$3,038 | \$4,557 |
| CN-GR2S-4284-? | 42 | 84 | 42 | \$3,141 | \$4,711 |
| CN-GR2S-4290-? | 42 | 90 | 42 | \$3,345 | \$5,017 |
| CN-GR2S-4296-? | 42 | 96 | 42 | \$3,448 | \$5,172 |
| CN-GR2S-4202-? | 42 | 102 | 42 | \$3,551 | \$5,326 |
| CN-GR2S-4208-? | 42 | 108 | 42 | \$3,654 | \$5,481 |
| CN-GR2S-4214-? | 42 | 114 | 42 | \$3,754 | \$5,632 |
| CN-GR2S-4220-? | 42 | 120 | 42 | \$3,857 | \$5,787 |

U-Shaped Wire Management Channel



| Model Number | Depth | Width | Height | Price |
|--------------|-------|-------|--------|-------|
| CN-UCHN-42 | 3 | 10 | 36 | \$225 |

- 3/4" thermofuse laminate material only. Ships with mounting hardware for securing to table base.

Grade 3

Desk Height Parsons Table



- 3" thick panels
- All panels HPL; TFL not available
- HPL self edge
- Mitered corner construction
- Recessed metal support rods
- Optional removable access door
- Ships assembled
- Tables over 96" available in Southern California and/or will call only

| Model Number | Width | Length | Height | TFL (T) | HPL (H) |
|-----------------|-------|--------|--------|---------|---------|
| 30" Wide | | | | | |
| CN-GR3D-3060-? | 30 | 60 | 29 | | \$4,346 |
| CN-GR3D-3066-? | 30 | 66 | 29 | | \$4,462 |
| CN-GR3D-3072-? | 30 | 72 | 29 | | \$4,535 |
| CN-GR3D-3078-? | 30 | 78 | 29 | | \$4,652 |
| CN-GR3D-3084-? | 30 | 84 | 29 | | \$4,726 |
| CN-GR3D-3090-? | 30 | 90 | 29 | | \$4,841 |
| CN-GR3D-3096-? | 30 | 96 | 29 | | \$4,916 |
| CN-GR3D-3002-? | 30 | 102 | 29 | | \$5,032 |
| CN-GR3D-3008-? | 30 | 108 | 29 | | \$5,105 |
| CN-GR3D-3014-? | 30 | 114 | 29 | | \$5,222 |
| CN-GR3D-3020-? | 30 | 120 | 29 | | \$5,296 |
| 36" Wide | | | | | |
| CN-GR3D-3660-? | 36 | 60 | 29 | | \$4,506 |
| CN-GR3D-3666-? | 36 | 66 | 29 | | \$4,628 |
| CN-GR3D-3672-? | 36 | 72 | 29 | | \$4,708 |
| CN-GR3D-3678-? | 36 | 78 | 29 | | \$4,830 |
| CN-GR3D-3684-? | 36 | 84 | 29 | | \$4,910 |
| CN-GR3D-3690-? | 36 | 90 | 29 | | \$5,032 |
| CN-GR3D-3696-? | 36 | 96 | 29 | | \$5,112 |
| CN-GR3D-3602-? | 36 | 102 | 29 | | \$5,233 |
| CN-GR3D-3608-? | 36 | 108 | 29 | | \$5,313 |
| CN-GR3D-3614-? | 36 | 114 | 29 | | \$5,435 |
| CN-GR3D-3620-? | 36 | 120 | 29 | | \$5,515 |
| 42" Wide | | | | | |
| CN-GR3D-4260-? | 42 | 60 | 29 | | \$4,668 |
| CN-GR3D-4266-? | 42 | 66 | 29 | | \$4,794 |
| CN-GR3D-4272-? | 42 | 72 | 29 | | \$4,881 |
| CN-GR3D-4278-? | 42 | 78 | 29 | | \$5,009 |
| CN-GR3D-4284-? | 42 | 84 | 29 | | \$5,094 |
| CN-GR3D-4290-? | 42 | 90 | 29 | | \$5,222 |
| CN-GR3D-4296-? | 42 | 96 | 29 | | \$5,308 |
| CN-GR3D-4202-? | 42 | 102 | 29 | | \$5,435 |
| CN-GR3D-4208-? | 42 | 108 | 29 | | \$5,521 |
| CN-GR3D-4214-? | 42 | 114 | 29 | | \$5,648 |
| CN-GR3D-4220-? | 42 | 120 | 29 | | \$5,735 |

Removable Access Panel



| Model Number | Width | Height | Price |
|--------------|-------|--------|-------|
| CN-ACPL-29 | 10 | 26 | \$286 |

- Price is for one removable access panel on one end of table.
- Removable panel is 3/4" material.

Grade 3

Standing Height Parsons Table

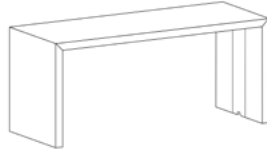

- 3" thick panels
- All panels HPL; TFL not available
- HPL self edge
- Mitered corner construction
- Recessed metal support rods
- Optional removable access door
- Ships assembled
- Tables over 96" available in Southern California and/or will call only

| Model Number | Width | Length | Height | TFL (T) | HPL (H) |
|-----------------|-------|--------|--------|---------|---------|
| 30" Wide | | | | | |
| CN-GR3S-3060-? | 30 | 60 | 42 | | \$4,643 |
| CN-GR3S-3066-? | 30 | 66 | 42 | | \$4,758 |
| CN-GR3S-3072-? | 30 | 72 | 42 | | \$4,833 |
| CN-GR3S-3078-? | 30 | 78 | 42 | | \$4,948 |
| CN-GR3S-3084-? | 30 | 84 | 42 | | \$5,022 |
| CN-GR3S-3090-? | 30 | 90 | 42 | | \$5,139 |
| CN-GR3S-3096-? | 30 | 96 | 42 | | \$5,212 |
| CN-GR3S-3002-? | 30 | 102 | 42 | | \$5,328 |
| CN-GR3S-3008-? | 30 | 108 | 42 | | \$5,403 |
| CN-GR3S-3014-? | 30 | 114 | 42 | | \$5,521 |
| CN-GR3S-3020-? | 30 | 120 | 42 | | \$5,592 |
| 36" Wide | | | | | |
| CN-GR3S-3660-? | 36 | 60 | 42 | | \$4,827 |
| CN-GR3S-3666-? | 36 | 66 | 42 | | \$4,948 |
| CN-GR3S-3672-? | 36 | 72 | 42 | | \$5,028 |
| CN-GR3S-3678-? | 36 | 78 | 42 | | \$5,150 |
| CN-GR3S-3684-? | 36 | 84 | 42 | | \$5,230 |
| CN-GR3S-3690-? | 36 | 90 | 42 | | \$5,352 |
| CN-GR3S-3696-? | 36 | 96 | 42 | | \$5,432 |
| CN-GR3S-3602-? | 36 | 102 | 42 | | \$5,554 |
| CN-GR3S-3608-? | 36 | 108 | 42 | | \$5,634 |
| CN-GR3S-3614-? | 36 | 114 | 42 | | \$5,755 |
| CN-GR3S-3620-? | 36 | 120 | 42 | | \$5,835 |
| 42" Wide | | | | | |
| CN-GR3S-4260-? | 42 | 60 | 42 | | \$5,011 |
| CN-GR3S-4266-? | 42 | 66 | 42 | | \$5,139 |
| CN-GR3S-4272-? | 42 | 72 | 42 | | \$5,225 |
| CN-GR3S-4278-? | 42 | 78 | 42 | | \$5,352 |
| CN-GR3S-4284-? | 42 | 84 | 42 | | \$5,438 |
| CN-GR3S-4290-? | 42 | 90 | 42 | | \$5,565 |
| CN-GR3S-4296-? | 42 | 96 | 42 | | \$5,651 |
| CN-GR3S-4202-? | 42 | 102 | 42 | | \$5,779 |
| CN-GR3S-4208-? | 42 | 108 | 42 | | \$5,865 |
| CN-GR3S-4214-? | 42 | 114 | 42 | | \$5,992 |
| CN-GR3S-4220-? | 42 | 120 | 42 | | \$6,079 |

Removable Access Panel



| Model Number | Width | Height | Price |
|--------------|-------|--------|-------|
| CN-ACPL-42 | 10 | 38 | \$312 |

- Price is for one removable access panel on one end of table.
 - Removable panel is 3/4" material.

GRADE 3 TABLES

Grade 4

Desk Height Parsons Table



- 3-3/8" thick panels
- All panels HPL; TFL not available
- Deskmakers standard 2MM PVC edge banding
- Recessed middle accent color stripe
- Mitered corner construction
- Recessed metal support rods
- Optional removable access door
- Ships assembled
- Tables over 96" available in Southern California and/or will call only

| Model Number | Width | Length | Height | TFL (T) | HPL (H) |
|-----------------|-------|--------|--------|---------|---------|
| 30" Wide | | | | | |
| CN-GR4D-3060-? | 30 | 60 | 29 | | \$6,002 |
| CN-GR4D-3066-? | 30 | 66 | 29 | | \$3,087 |
| CN-GR4D-3072-? | 30 | 72 | 29 | | \$6,321 |
| CN-GR4D-3078-? | 30 | 78 | 29 | | \$6,526 |
| CN-GR4D-3084-? | 30 | 84 | 29 | | \$6,639 |
| CN-GR4D-3090-? | 30 | 90 | 29 | | \$6,844 |
| CN-GR4D-3096-? | 30 | 96 | 29 | | \$6,959 |
| CN-GR4D-3002-? | 30 | 102 | 29 | | \$7,164 |
| CN-GR4D-3008-? | 30 | 108 | 29 | | \$7,278 |
| CN-GR4D-3014-? | 30 | 114 | 29 | | \$7,483 |
| CN-GR4D-3020-? | 30 | 120 | 29 | | \$7,596 |
| 36" Wide | | | | | |
| CN-GR4D-3660-? | 36 | 60 | 29 | | \$6,255 |
| CN-GR4D-3666-? | 36 | 66 | 29 | | \$6,469 |
| CN-GR4D-3672-? | 36 | 72 | 29 | | \$6,590 |
| CN-GR4D-3678-? | 36 | 78 | 29 | | \$6,805 |
| CN-GR4D-3684-? | 36 | 84 | 29 | | \$6,926 |
| CN-GR4D-3690-? | 36 | 90 | 29 | | \$7,141 |
| CN-GR4D-3696-? | 36 | 96 | 29 | | \$7,262 |
| CN-GR4D-3602-? | 36 | 102 | 29 | | \$7,477 |
| CN-GR4D-3608-? | 36 | 108 | 29 | | \$7,599 |
| CN-GR4D-3614-? | 36 | 114 | 29 | | \$7,812 |
| CN-GR4D-3620-? | 36 | 120 | 29 | | \$7,935 |
| 42" Wide | | | | | |
| CN-GR4D-4260-? | 42 | 60 | 29 | | \$6,508 |
| CN-GR4D-4266-? | 42 | 66 | 29 | | \$6,730 |
| CN-GR4D-4272-? | 42 | 72 | 29 | | \$6,861 |
| CN-GR4D-4278-? | 42 | 78 | 29 | | \$7,082 |
| CN-GR4D-4284-? | 42 | 84 | 29 | | \$7,213 |
| CN-GR4D-4290-? | 42 | 90 | 29 | | \$7,436 |
| CN-GR4D-4296-? | 42 | 96 | 29 | | \$7,567 |
| CN-GR4D-4202-? | 42 | 102 | 29 | | \$7,790 |
| CN-GR4D-4208-? | 42 | 108 | 29 | | \$7,921 |
| CN-GR4D-4214-? | 42 | 114 | 29 | | \$8,142 |
| CN-GR4D-4220-? | 42 | 120 | 29 | | \$8,273 |

Removable Access Panel



| Model Number | Width | Height | Price |
|--------------|-------|--------|-------|
| CN-ACPL-29 | 10 | 26 | \$286 |

- Price is for one removable access panel on one end of table.
- Removable panel is 3/4" material.

Grade 4

Standing Height Parsons Table

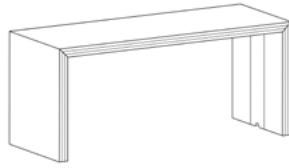

- 3-3/8" thick panels
- All panels HPL; TFL not available
- Deskmakers standard 2MM PVC edge banding
- Recessed middle accent color stripe
- Mitered corner construction
- Recessed metal support rods
- Optional removable access door
- Ships assembled
- Tables over 96" available in Southern California and/or will call only

| Model Number | Width | Length | Height | TFL (T) | HPL (H) |
|-----------------|-------|--------|--------|---------|---------|
| 30" Wide | | | | | |
| CN-GR4S-3060-? | 30 | 60 | 42 | | \$6,457 |
| CN-GR4S-3066-? | 30 | 66 | 42 | | \$6,662 |
| CN-GR4S-3072-? | 30 | 72 | 42 | | \$6,777 |
| CN-GR4S-3078-? | 30 | 78 | 42 | | \$6,982 |
| CN-GR4S-3084-? | 30 | 84 | 42 | | \$7,095 |
| CN-GR4S-3090-? | 30 | 90 | 42 | | \$7,300 |
| CN-GR4S-3096-? | 30 | 96 | 42 | | \$7,414 |
| CN-GR4S-3002-? | 30 | 102 | 42 | | \$7,619 |
| CN-GR4S-3008-? | 30 | 108 | 42 | | \$7,733 |
| CN-GR4S-3014-? | 30 | 114 | 42 | | \$7,938 |
| CN-GR4S-3020-? | 30 | 120 | 42 | | \$8,052 |
| 36" Wide | | | | | |
| CN-GR4S-3660-? | 36 | 60 | 42 | | \$6,744 |
| CN-GR4S-3666-? | 36 | 66 | 42 | | \$6,958 |
| CN-GR4S-3672-? | 36 | 72 | 42 | | \$7,080 |
| CN-GR4S-3678-? | 36 | 78 | 42 | | \$7,294 |
| CN-GR4S-3684-? | 36 | 84 | 42 | | \$7,416 |
| CN-GR4S-3690-? | 36 | 90 | 42 | | \$7,629 |
| CN-GR4S-3696-? | 36 | 96 | 42 | | \$7,752 |
| CN-GR4S-3602-? | 36 | 102 | 42 | | \$7,966 |
| CN-GR4S-3608-? | 36 | 108 | 42 | | \$8,089 |
| CN-GR4S-3614-? | 36 | 114 | 42 | | \$8,302 |
| CN-GR4S-3620-? | 36 | 120 | 42 | | \$8,425 |
| 42" Wide | | | | | |
| CN-GR4S-4260-? | 42 | 60 | 42 | | \$7,031 |
| CN-GR4S-4266-? | 42 | 66 | 42 | | \$7,254 |
| CN-GR4S-4272-? | 42 | 72 | 42 | | \$7,385 |
| CN-GR4S-4278-? | 42 | 78 | 42 | | \$7,607 |
| CN-GR4S-4284-? | 42 | 84 | 42 | | \$7,738 |
| CN-GR4S-4290-? | 42 | 90 | 42 | | \$7,960 |
| CN-GR4S-4296-? | 42 | 96 | 42 | | \$8,091 |
| CN-GR4S-4202-? | 42 | 102 | 42 | | \$8,314 |
| CN-GR4S-4208-? | 42 | 108 | 42 | | \$8,444 |
| CN-GR4S-4214-? | 42 | 114 | 42 | | \$8,666 |
| CN-GR4S-4220-? | 42 | 120 | 42 | | \$8,797 |

Removable Access Panel



| Model Number | Width | Height | Price |
|--------------|-------|--------|-------|
| CN-ACPL-42 | 10 | 38 | \$312 |

- Price is for one removable access panel on one end of table.
- Removable panel is 3/4" material.

**Please see website for current Terms and Conditions:
www.deskmakers.com**

Limited Lifetime Warranty

(Effective for Furniture Sold as of January 1, 2015)

DeskMakers, Inc. furniture is warranted against defects in material and workmanship given normal usage and care for as long the original purchaser owns it.

DeskMakers will repair or replace at its option, and at its own cost, any product that develops a defect during the warranty period. In some cases, DeskMakers may elect to refund the customer's original purchase price (less reasonable depreciation) in lieu of repair or replacement. Repair, replacement, or refund is the purchaser's sole remedy, the choice of which rests solely with DeskMakers. DeskMakers shall not be liable for any incidental or consequential damages including lost profits and loss of use of product.

Limitations:

- The warranty for wood guest chair frames shall be limited to 10 years.
- The warranty for PVC edges, wood veneer edges, HPL edges, mechanical parts such as ball bearing slides, door hinges, floor glides, fabric (except for COM fabrics), seating foam, and wood veneer surfaces shall be limited to five (5) years.
- The warranty for training tables shall be limited to three (3) years.
- The warranty for engineered-to-order "custom" products shall be limited to three (3) years.
- This warranty does not cover:
 - o Normal wear and tear.
 - o The color fastness of any laminate, wood, or fabric, as such colors can fade or darken with normal use and as a result of exposure to light.
 - o Customer's Own Materials (COM).
 - o Damage caused by placing anything other than hanging files in file drawers.
 - o Rental furniture.
 - o Labor and service.

Normal Usage:

This warranty does not apply to damages or failures resulting from misuse, abuse, negligence, or improper care. For casegoods, tables, and desking, normal usage is limited to 40 hours per week. For seating, normal usage is limited to 40 hours per week by individuals of 250 lbs. or less.

Showroom Locations

Los Angeles

DeskMakers Headquarters
6525 Flotilla Street
Commerce, CA 90040

DeskMakers

Phone: 323.264.2260 | Fax: 323.725.6960
www.deskmakers.com