



hotspot tables

PRICE & SPECIFICATION GUIDE

Version: 11.03.25
prices effective January 1, 2026

DeskMakers

revisions

08/15/25	Pricebook Launch
11/03/25	Updated Pricing

table of contents

Laminate Finishes	4
Product Details	5
Hotspot Table Tops	6-7
Conference Table Frames	8-9
Tall Table Frames	10-13
Electrical	14-19
Terms and Conditions	20
Warranty	21

thermofuse laminate (TFL)

Pricing shown in this price list applies only to TFL finishes currently included in the DeskMakers finish collection. For the most accurate finish list please see deskmakers.com.

high pressure laminate (HPL)

"H1" Standard HPL

Pricing shown in this price list applies only to non-premium HPLs as follows:

- Wilsonart: Solids, Woodgrains, and Abstracts in Matte (-60) finish,
- Formica: Color Portfolio, Woodgrains, and Patterns in Matte (-58) finish
- Pionite: Solids, Woodgrains, and Abstracts in Suede (N) finish
- Arborite: Solids, Woodgrains, Textures and Abstracts in Matte (CA) finish
- Nevamar: Solids, Woodgrains, Stones and Abstracts in ARP (-T) finish

A minimum charge of \$573 net per HPL color will be applied to each order.

Call customer service for pricing for all other HPLs.

Additional lead times required for HPL orders depending on material availability and order complexity.

HPL is always available with DeskMakers standard 2MM edgebanding. Special order matching PVC 2MM edgebanding may be available for orders \$25,000 List or larger, call customer service for pricing.

"H2" Premium HPL

Pricing shown in this price list applies only the specific premium HPLs listed below:

- White High Gloss Dry Erase - Formica White 949-90

top shapes

Hotspot conference tables have a rectangle-shaped top with 3" radius corners. For other top shapes that utilize the same base see the Thinktank and Kayak collections.



rounded rectangle

product details

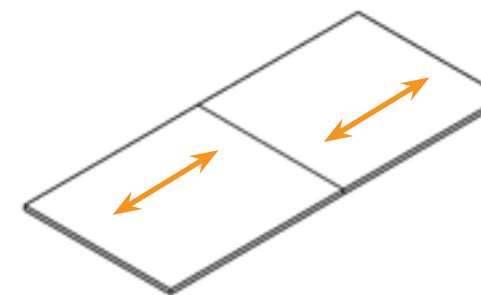

grain direction:

grain direction runs length of the table
grain pattern will not line up at the seam of multi-part tables

construction:

multi-part table tops are divided into equal sections
assembled with tite-joint fasteners and alignment biscuits
all edges are edge-banded
tops are pre-drilled to fit Hotspot Series bases

dimensions:

depths: 36, 42, 48", 54" and 60"
lengths: 72" -192"

edges

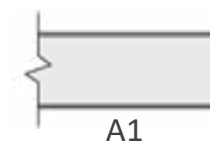

group a

1-1/8" thick top
2mm PVC edge

Matching edgeband is available for all finishes in the DeskMakers Collection. Select accent colors may also be available to create a contrast effect. For the most accurate finish list please see deskmakers.com.

One Piece Table Tops

pricing

Model Number	Width	Length	T1	T2	H1	H2
36" Wide						
SC-HTSP-3672-??-A1	36	72	\$1,062	\$1,169	\$1,558	\$1,837
SC-HTSP-3684-??-A1	36	84	\$1,158	\$1,273	\$1,698	\$2,002
SC-HTSP-3696-??-A1	36	96	\$1,253	\$1,378	\$1,838	\$2,166
42" Wide						
SC-HTSP-4272-??-A1	42	72	\$1,099	\$1,209	\$1,713	\$2,018
SC-HTSP-4284-??-A1	42	84	\$1,179	\$1,296	\$1,858	\$2,190
SC-HTSP-4296-??-A1	42	96	\$1,289	\$1,418	\$1,912	\$2,254
48" Wide						
SC-HTSP-4872-??-A1	48	72	\$1,128	\$1,241	\$1,761	\$2,075
SC-HTSP-4884-??-A1	48	84	\$1,194	\$1,313	\$1,890	\$2,227
SC-HTSP-4896-??-A1	48	96	\$1,408	\$1,549	\$2,092	\$2,465
54" Wide						
SC-HTSP-5472-??-A1	54	72	\$1,156	\$1,272	\$1,806	\$2,128
SC-HTSP-5484-??-A1	54	84	\$1,337	\$1,470	\$2,101	\$2,477
SC-HTSP-5496-??-A1	54	96	\$1,653	\$1,818	\$2,469	\$2,909
60" Wide						
SC-HTSP-6072-??-A1	60	72	\$1,246	\$1,370	\$1,953	\$2,301
SC-HTSP-6084-??-A1	60	84	\$1,517	\$1,669	\$2,400	\$2,829
SC-HTSP-6096-??-A1	60	96	\$1,771	\$1,948	\$2,647	\$3,120

- All tops have 2mm PVC edges and are only available with DeskMakers standard 2MM PVC edgebanding.
- For electrical options, please see pages 14-19
- Hot Spot tables have 3" radius corners.

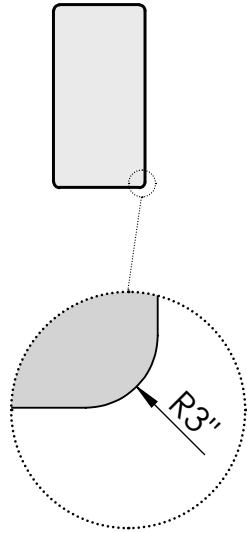

Two Piece Table Tops

pricing

Model Number	Width	Length	T1	T2	H1	H2
36" Wide						
SC-HTSP-3620-??-A1	36	120	\$1,871	\$2,059	\$2,748	\$3,238
SC-HTSP-3644-??-A1	36	144	\$1,993	\$2,193	\$2,925	\$3,447
SC-HTSP-3668-??-A1	36	168	\$2,213	\$2,434	\$3,248	\$3,828
SC-HTSP-3692-??-A1	36	192	\$2,686	\$2,955	\$3,943	\$4,647
42" Wide						
SC-HTSP-4220-??-A1	42	120	\$2,111	\$2,322	\$3,343	\$3,940
SC-HTSP-4244-??-A1	42	144	\$2,350	\$2,585	\$3,517	\$4,145
SC-HTSP-4268-??-A1	42	168	\$4,315	\$4,747	\$4,061	\$4,787
SC-HTSP-4292-??-A1	42	192	\$3,197	\$3,517	\$4,817	\$5,678
48" Wide						
SC-HTSP-4820-??-A1	48	120	\$2,350	\$2,585	\$3,736	\$4,403
SC-HTSP-4844-??-A1	48	144	\$2,706	\$2,976	\$4,061	\$4,787
SC-HTSP-4868-??-A1	48	168	\$3,197	\$3,517	\$4,817	\$5,678
SC-HTSP-4892-??-A1	48	192	\$3,709	\$4,080	\$5,603	\$6,603
54" Wide						
SC-HTSP-5420-??-A1	54	120	\$2,723	\$2,995	\$4,343	\$5,118
SC-HTSP-5444-??-A1	54	144	\$3,003	\$3,303	\$4,519	\$5,326
SC-HTSP-5468-??-A1	54	168	\$3,478	\$3,826	\$5,248	\$6,185
SC-HTSP-5492-??-A1	54	192	\$4,036	\$4,439	\$6,101	\$7,190
60" Wide						
SC-HTSP-6020-??-A1	60	120	\$2,982	\$3,280	\$4,769	\$5,621
SC-HTSP-6044-??-A1	60	144	\$3,284	\$3,612	\$4,951	\$5,835
SC-HTSP-6068-??-A1	60	168	\$3,806	\$4,187	\$5,750	\$6,776
SC-HTSP-6092-??-A1	60	192	\$4,415	\$4,856	\$6,689	\$7,883

- All tops have 2mm PVC edges and are only available with DeskMakers standard 2MM PVC edgebanding.
- Hot Spot tables have 3" radius corners.
- For two piece and three piece table tops, please note that the grain pattern will not line up at the seams.
- Two piece table tops are divided into two equal sections.
- For electrical options, please see pages 14-19.

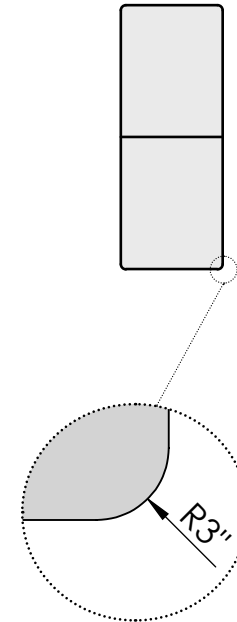

For 36, 42" and 48" Wide Table Tops

pricing

Model Number	Table Width	Table Length	Base Size	# of Legs	Price
2 Bases					
SC-BDH2-3278	36, 42, 48	72, 78	31-1/2	2	\$2,356
SC-BDH2-3290	36, 42, 48	84, 90	31-1/2	2	\$2,458
SC-BDH2-3296	36, 42, 48	96	31-1/2	2	\$2,542
SC-BDH2-3220	36, 42, 48	108, 120	31-1/2	2	\$3,098
3 Bases					
SC-BDH3-3256	36, 42, 48	144	31-1/2	3	\$4,136
SC-BDH3-3280	36, 42, 48	168	31-1/2	3	\$4,474
SC-BDH3-3292	36, 42, 48	192	31-1/2	3	\$4,628



- Bases and frames are constructed of steel with a white powdercoat finish.
- Includes leveling glides.
- Shipped in pieces and require assembly.

For 54" and 60" Wide Table Tops

pricing

Model Number	Table Width	Table Length	Base Size	# of Legs	Price
2 Bases					
SC-BDH2-4478	54, 60	72, 78	43-1/2	2	\$2,900
SC-BDH2-4490	54, 60	84, 90	43-1/2	2	\$3,002
SC-BDH2-4496	54, 60	96	43-1/2	2	\$3,086
SC-BDH2-4420	54, 60	108, 120	43-1/2	2	\$3,642
3 Bases					
SC-BDH3-4456	54, 60	144	43-1/2	3	\$4,888
SC-BDH3-4480	54, 60	168	43-1/2	3	\$5,290
SC-BDH3-4492	54, 60	192	43-1/2	3	\$5,444

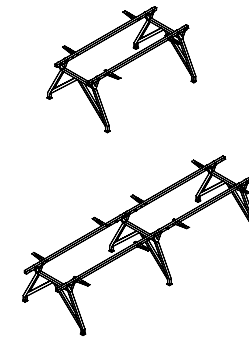

- Bases and frames are constructed of steel with a white powdercoat finish.
- Includes leveling glides.
- Shipped in pieces and require assembly.

For 36, 42" and 48" Wide Table Tops

pricing

Model Number	Table Width	Table Length	Base Size	# of Legs	Price
2 Bases					
SC-BCH2-3278	36, 42, 48	54, 60, 72, 78	31-1/2	2	\$2,576
SC-BCH2-3290	36, 42, 48	84, 90	31-1/2	2	\$2,678
SC-BCH2-3208	36, 42, 48	96, 108	31-1/2	2	\$2,762
SC-BCH2-3220	36, 42, 48	120	31-1/2	2	\$3,318

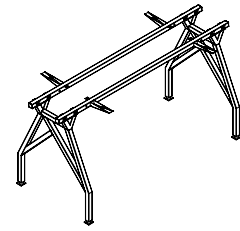

Counter Height with levelers

- Bases and frames are constructed of steel with a white powdercoat finish.
- Includes leveling glides.
- Shipped in pieces and require assembly.

pricing

Model Number	Table Width	Table Length	Base Size	# of Legs	Price
2 Bases					
SC-BCHC-3278	36, 42, 48	54, 60, 72, 78	31-1/2	2	\$2,852
SC-BCHC-3290	36, 42, 48	84, 90	31-1/2	2	\$2,954
SC-BCHC-3208	36, 42, 48	96, 108	31-1/2	2	\$3,038
SC-BCHC-3220	36, 42, 48	120	31-1/2	2	\$3,594

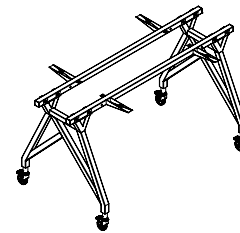

Counter Height with casters

- Bases and frames are constructed of steel with a white powdercoat finish.
- Includes locking casters.
- Shipped in pieces and require assembly.

For 54" and 60" Wide Table Tops

pricing

Model Number	Table Width	Table Length	Base Size	# of Legs	Price
2 Bases					
SC-BSH2-4478	54, 60	72, 78	43-1/2	2	\$3,350
SC-BSH2-4490	54, 60	84, 90	43-1/2	2	\$3,452
SC-BSH2-4408	54, 60	96, 108	43-1/2	2	\$3,536
SC-BSH2-4420	54, 60	120	43-1/2	2	\$4,092

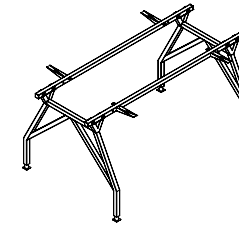

Counter Height with levelers

- Bases and frames are constructed of steel with a white powdercoat finish.
- Includes leveling glides.
- Shipped in pieces and require assembly.

pricing

Model Number	Table Width	Table Length	Base Size	# of Legs	Price
2 Bases					
SC-BCHC-4478	54, 60	54, 60, 72, 78	43-1/2	2	\$3,396
SC-BCHC-4490	54, 60	84, 90	43-1/2	2	\$3,498
SC-BCHC-4408	54, 60	96, 108	43-1/2	2	\$3,582
SC-BCHC-4420	54, 60	120	43-1/2	2	\$4,138

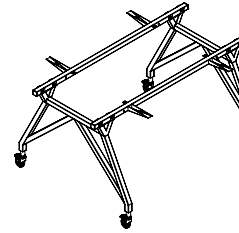

Counter Height with casters

- Bases and frames are constructed of steel with a white powdercoat finish.
- Includes locking casters.
- Shipped in pieces and require assembly.

For 36, 42" and 48" Wide Table Tops

pricing

Model Number	Table Width	Table Length	Base Size	# of Legs	Price
2 Bases					
SC-BSH2-3278	36, 42, 48	72, 78	31-1/2	2	\$2,754
SC-BSH2-3290	36, 42, 48	84, 90	31-1/2	2	\$2,856
SC-BSH2-3208	36, 42, 48	96, 108	31-1/2	2	\$2,940
SC-BSH2-3220	36, 42, 48	120	31-1/2	2	\$3,496

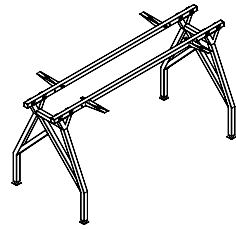

Standing Height with levelers

- Bases and frames are constructed of steel with a white powdercoat finish.
- Includes leveling glides.
- Shipped in pieces and require assembly.

pricing

Model Number	Table Width	Table Length	Base Size	# of Legs	Price
2 Bases					
SC-BSHC-3278	36, 42, 48	54, 60, 72, 78	31-1/2	2	\$3,072
SC-BSHC-3290	36, 42, 48	84, 90	31-1/2	2	\$3,174
SC-BSHC-3208	36, 42, 48	96, 108	31-1/2	2	\$3,258
SC-BSHC-3220	36, 42, 48	120	31-1/2	2	\$3,814

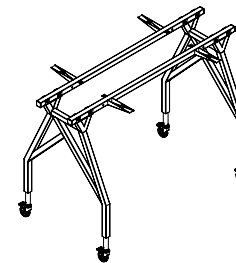

Standing Height with casters

- Bases and frames are constructed of steel with a white powdercoat finish.
- Includes locking casters.
- Shipped in pieces and require assembly.

For 54" and 60" Wide Table Tops

pricing

Model Number	Table Width	Table Length	Base Size	# of Legs	Price
2 Bases					
SC-BSH2-4478	54, 60	72, 78	43-1/2	2	\$3,350
SC-BSH2-4490	54, 60	84, 90	43-1/2	2	\$3,452
SC-BSH2-4408	54, 60	96, 108	43-1/2	2	\$3,536
SC-BSH2-4420	54, 60	120	43-1/2	2	\$4,092

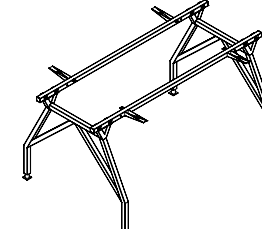

Standing Height with levelers

- Bases and frames are constructed of steel with a white powdercoat finish.
- Includes leveling glides.
- Shipped in pieces and require assembly.

pricing

Model Number	Table Width	Table Length	Base Size	# of Legs	Price
2 Bases					
SC-BSHC-4478	54, 60	54, 60, 72, 78	43-1/2	2	\$3,674
SC-BSHC-4490	54, 60	84, 90	43-1/2	2	\$3,776
SC-BSHC-4408	54, 60	96, 108	43-1/2	2	\$3,860
SC-BSHC-4420	54, 60	120	43-1/2	2	\$4,416

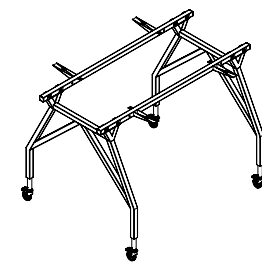

Standing Height with casters

- Bases and frames are constructed of steel with a white powdercoat finish.
- Includes locking casters.
- Shipped in pieces and require assembly.

Hotspot Tables Electrical Guide

Refer to the Conference Table Grommet Guide on the DeskMakers Website for Grommet locations. The Electrical Grommets listed on the following pages are compatible with all Hotspot Conference Tables in either horizontal or vertical orientation - additional options are available in the DeskMakers Electrical Pricebook but may not be suitable for all applications. 36"-48" wide table will have 9 1/2" clear in the center between support struts. Tables 54"-60" will have 24" clear. Please confirm with customer service if specifying electrical other than what is included in this pricebook.

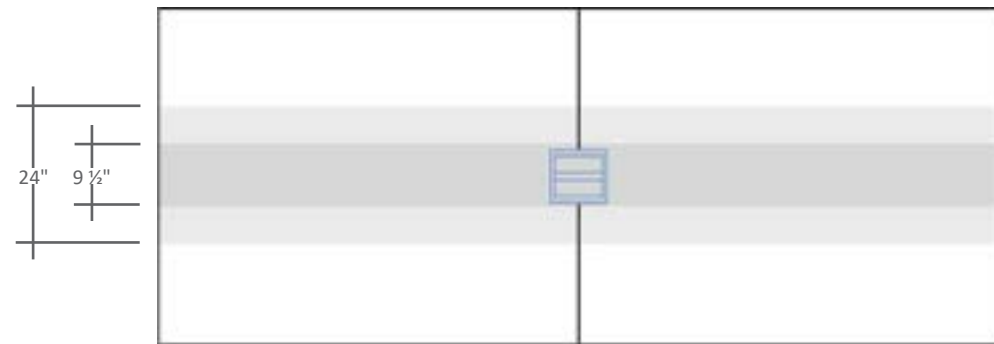

AC-PWRG-06 Grommet Power with USB Charging



Specifications

- Round 3" grommet hole
- (2) Spill resistant power outlets
- (3) 2.1A USB charging ports
- (1) USB-C charging port
- (1) 72" long 15amp plug cord
- (1) Convenience outlet underneath unit
- Mounting Ring
- Available finishes: Black, and White

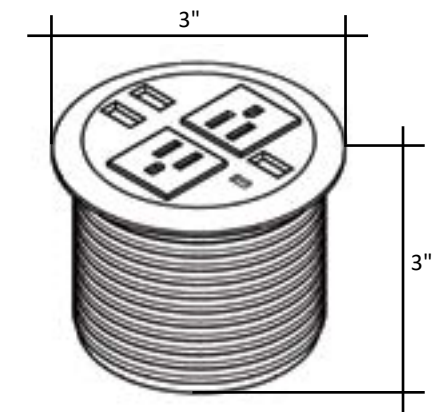

Model Number		Price
AC-PWRG-06-WT	white	\$151
AC-PWRG-06-BK	black	\$151

AC-DPGR-78

Pop-up Power and Data Unit with USB Charging



Specifications

- (3) power outlets
- (2) 2.1A USB charging ports
- (2) 45W USBC charging ports
- (1) RJ-45 Cat 6 Data port
- (1) HDMI port
- (1) Open data port
- (2) 120" long 15amp plug cords
- Available finishes: White and Silver

Recommended Use

- All Conference Tables
- EYHOV Sport in CV position
- TeleMeet Collection
- Not Recommended for Nomad
- Not Recommended for Training Tables

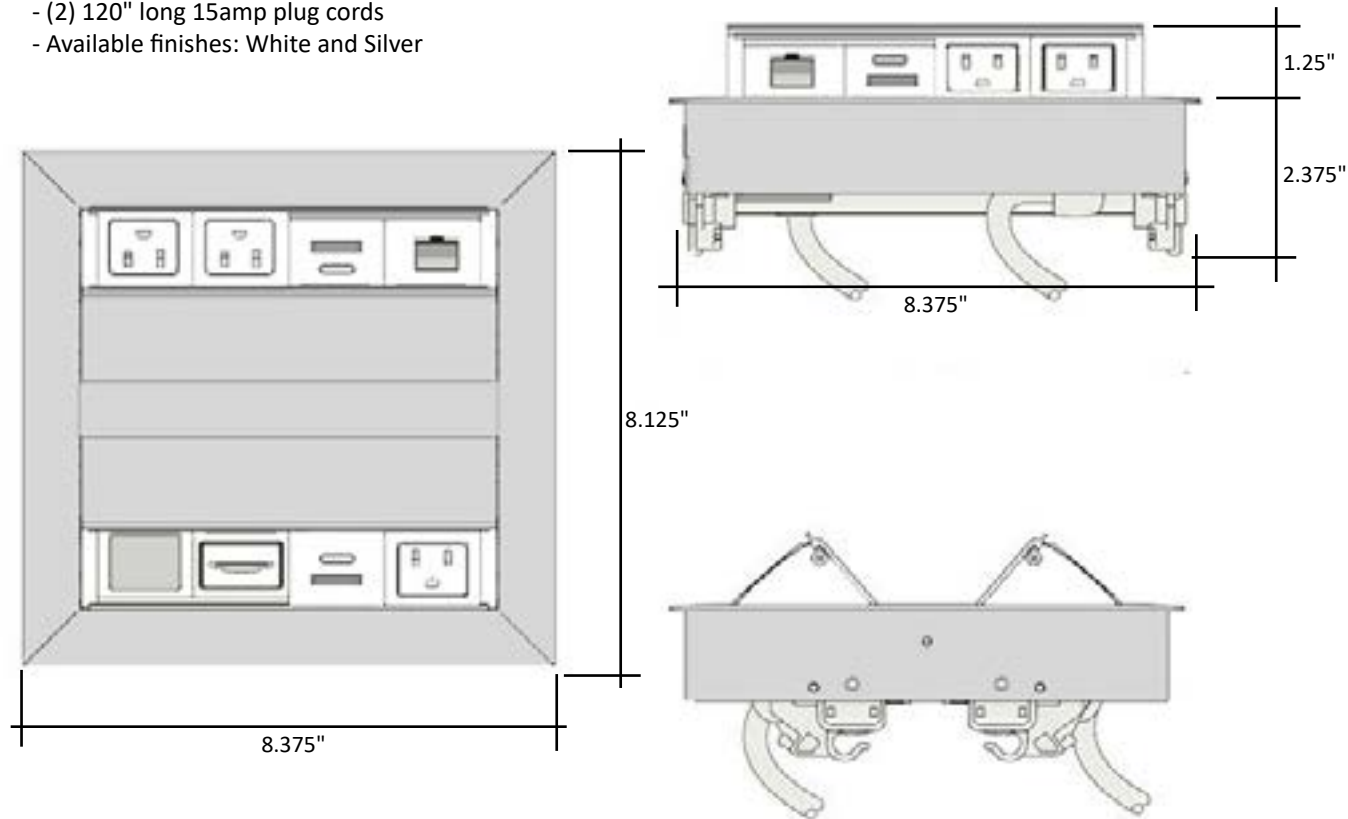

Model Number	Color	Price
AC-DPGR-78-WT	white	\$2,041
AC-DPGR-78-SV	silver	\$2,041
AC-DPGR-78-BK	black	\$2,480

AC-DPGR-79

Recessed Power and Data Unit with USB Charging



Specifications

- (4) power outlets
- (2) 2.1A USB charging ports
- (2) 45W USBC charging ports
- (1) RJ-45 Data port
- (1) HDMI port
- (2) 120" long 15amp plug cords
- Available finishes: White, and Silver

Recommended Use

- All Conference Tables
- EYHOV Sport in CV position
- TeleMeet Collection
- Not Recommended for Nomad
- Not Recommended for Training Tables

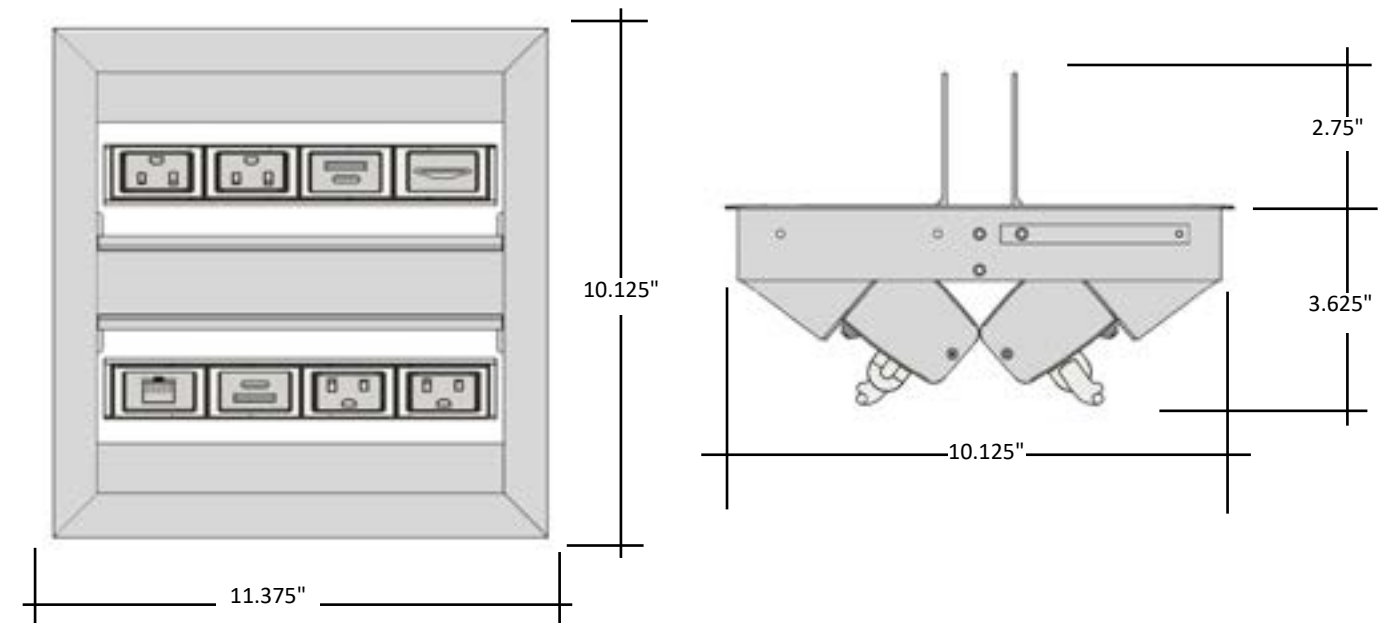

Model Number	Color	Price
AC-DPGR-79-WT	white	\$2,191
AC-DPGR-79-SV	silver	\$2,191
AC-DPGR-79-BK	black	\$2,375

Round Grommet



Model Number	Description	Price
AC-GROM-1	2.5" black plastic grommet	\$60
AC-GROM-2	2.5" white plastic grommet	\$60
AC-GROM-6	2.5" stainless steel grommet	\$81

- Reference grommet guides for grommet placement.

Rectangle Grommet



Model Number	Description	Price
AC-GROM-35	3 3/4" x 2 1/4" stainless steel grommet	\$88

- Reference grommet guides for grommet placement.

V2 System Hinged Grommet



Model Number	Description	Price
AC-ELV2-08-BL	5.7" x 3.4" black hinged grommet	\$229
AC-ELV2-08-PL	5.7" x 3.4" silver hinged grommet	\$178
AC-ELV2-08-WT	5.7" x 3.4" white hinged grommet	\$229
AC-ELV2-08-ST	5.7" x 3.4" brushed stainless hinged grommet	\$307

- Reference grommet guides for grommet placement.

Large Hinged Grommet



	Description	Price
AC-ELV2-LG-BK	8" x 4" black hinged grommet	\$244
AC-ELV2-LG-PL	8" x 4" silver hinged grommet	\$244
AC-ELV2-LG-WT	8" x 4" white hinged grommet	\$244

- Reference grommet guides for grommet placement.

Cable Spine Wire Manager



Model Number	Color	Length	Price
AC-MGMT-CS50-BK	black	50"	\$155
AC-MGMT-CS50-SV	silver	50"	\$155
AC-MGMT-CS50-WT	white	50"	\$155

- Plastic material. Includes mounting bracket, and metal base plate. Links easily disconnect to adjust length.
 - Links are 1 1/4" x 2-1/2".
 - Appropriate for use with height adjustable or fixed height tables.

G-Shaped Plastic Wire Management Channel



Model Number	Length	Price
AC-MGMT-GCHN	per 8 linear feet	\$96

- Channel size is 1-1/2" x 1-1/2".
 - Secures with screws, staples or double-sided tape.
 - Flexible corner opening for easy insertion of wires.
 - Supplied in 8-foot increments only. Must be field installed.

Cable Tray



Model Number	Width	Length	Height	Price
AC-MGMT-TRAY-20	2 1/2	20	3 1/2	\$97
AC-MGMT-TRAY-32	2 1/2	32	3 1/2	\$119
AC-MGMT-TRAY-44	2 1/2	44	3 1/2	\$143
AC-MGMT-TRAY-56	2 1/2	56	3 1/2	\$219
AC-MGMT-TRAY-68	2 1/2	68	3 1/2	\$259

- Silver (Aluminum).
 - Mounts under desktop with woodscrews (included).
 - Low-profile wire tray ideal for use under height adjustable desks.

Wire Management Basket



Model Number	Color	Price
SC-STCB-B	black	\$128

- Mounting brackets are integrated into basket for ease of installation.
 - Silver finish.
 - Size: 7"x30"x4.25"H

Flex Wire Manager



Model Number	Width	Length	Price
AC-MGMT-FLEX	1 1/2	5 3/8	\$19

- Price is for one unit.
 - Secures with single screw.
 - Grey plastic.

Velcro Wire Manager



Model Number	Width	Length	Price
AC-MGMT-VELCRO	1 3/4	3 1/2	\$26

- Price is for one unit.
 - Secures with double-sided tape.
 - Black plastic and black velcro.

Please visit Deskmakers.com to view our current [Terms and Conditions](#).

Please visit Deskmakers.com to view our current [Warranty](#).

Showroom Locations

Los Angeles

DeskMakers Headquarters
6525 Flotilla Street
Commerce, CA 90040

Dallas

Factory
1110 Inwood Road Suite 101
Dallas, TX 75247

DeskMakers

Phone: 323.264.2260 | Fax: 323.725.6960
www.deskmakers.com