

Hang-On Transaction Counter

Installation Instructions



Desk**Makers**

Transaction Counter Installation Instructions

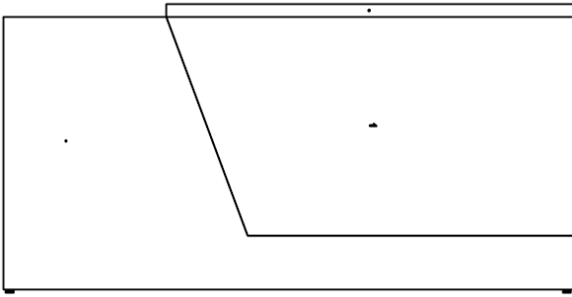

Angled Hang-On Transaction Counter

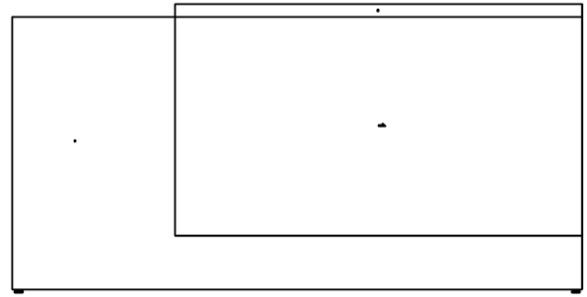

Hang-On Transaction Counter

Possible Placements

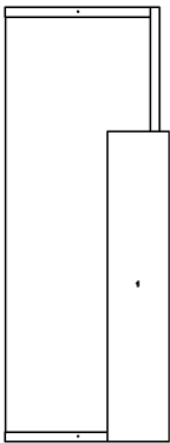

Right Placement

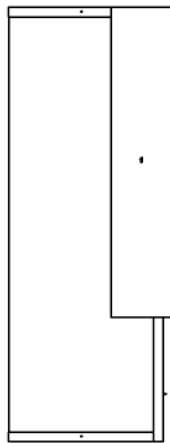

Left Placement

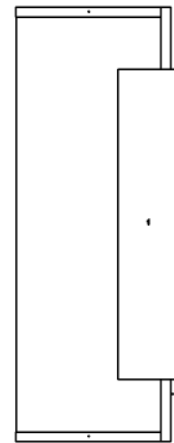

Center Placement

(Not Applicable For Angled Hang-On Transaction)

Transaction Counter Installation Instructions

- 1 Position Stack-On Counter on the Transaction Height Desk

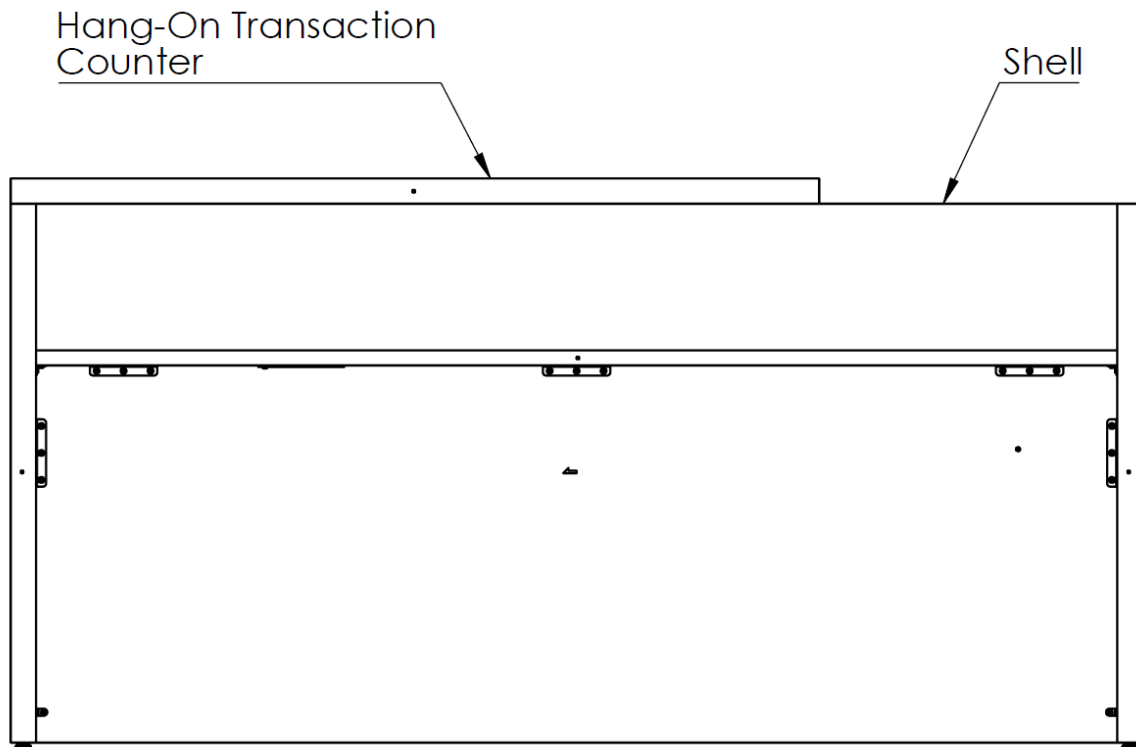

Transaction Counter Installation Instructions

- 2 Secure Stack-On Counter with Screws (#8 x 2-1/2" Long Flat Head Screws) as shown below.

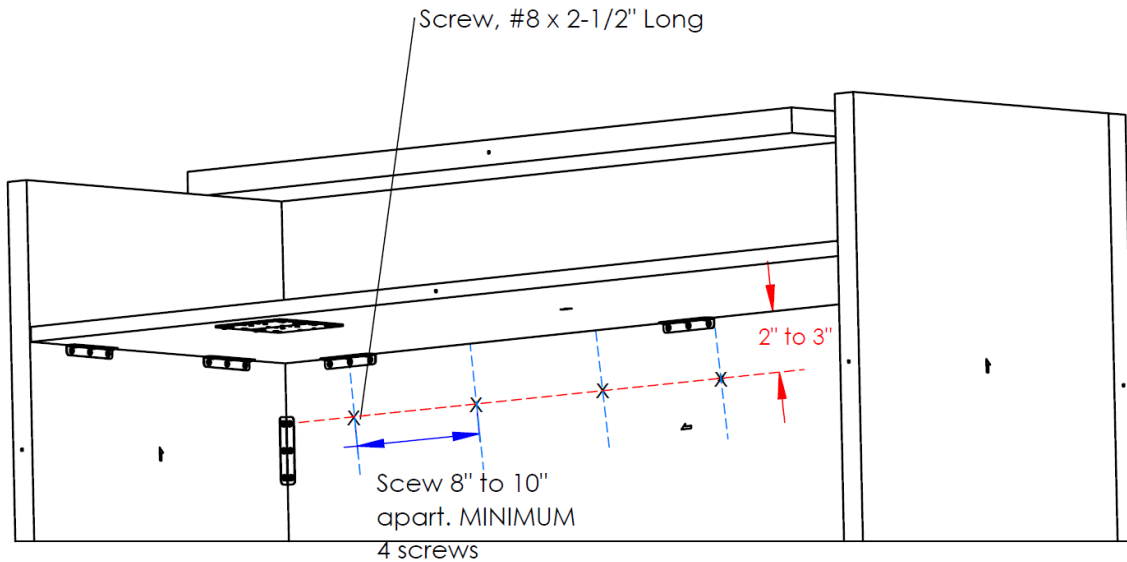

SECTION VIEW

