

# Hang-On Transaction Counter

Installation Instructions



Desk**Makers**

## Transaction Counter Installation Instructions

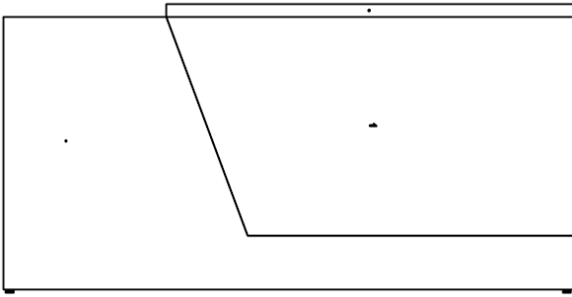

Angled Hang-On Transaction Counter

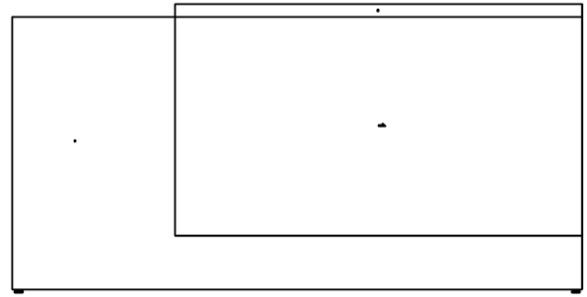

Hang-On Transaction Counter

## Possible Placements

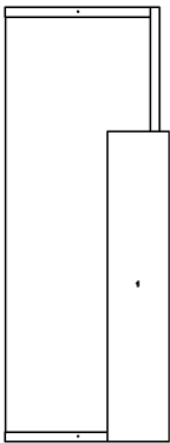

Right Placement

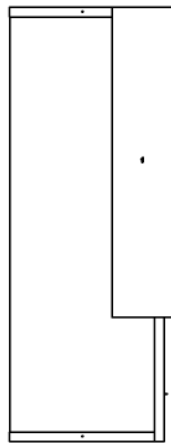

Left Placement

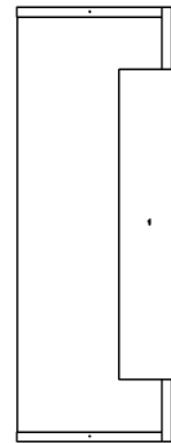

Center Placement

(Not Applicable For Angled Hang-On Transaction)

## Transaction Counter Installation Instructions

- 1 Position Stack-On Counter on the Transaction Height Desk

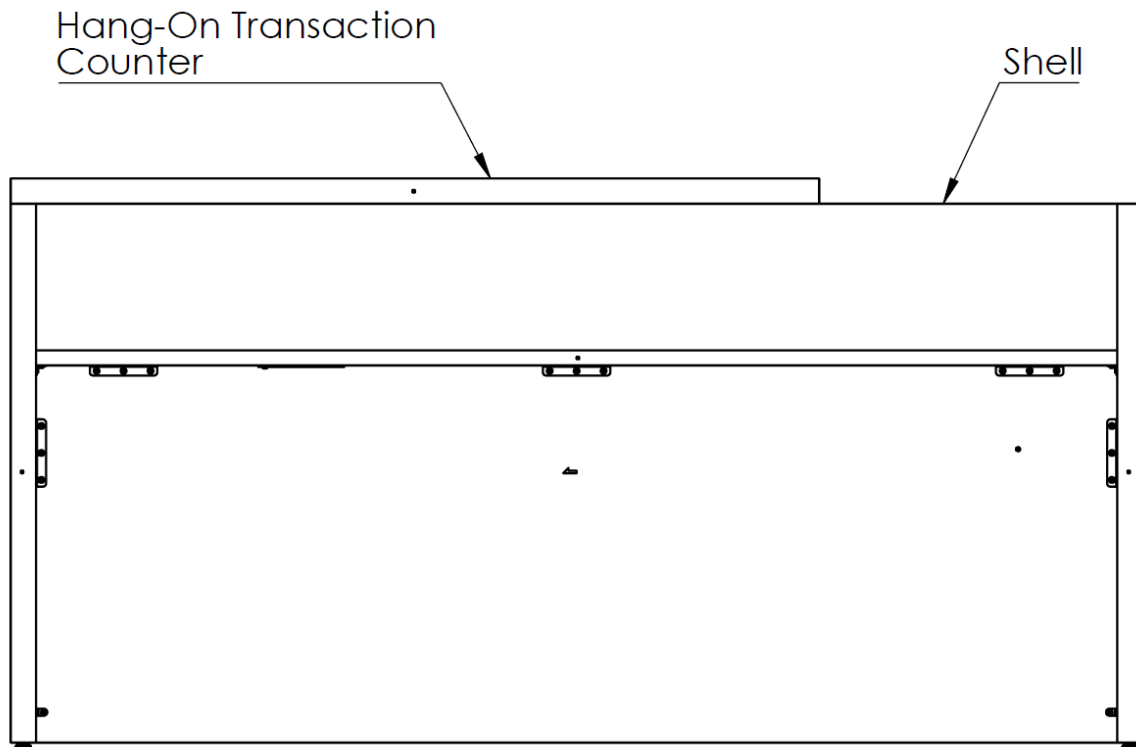

## Transaction Counter Installation Instructions

- Secure Stack-On Counter with Screws (#8 x 2-1/2" Long Flat Head Screws) as shown below.

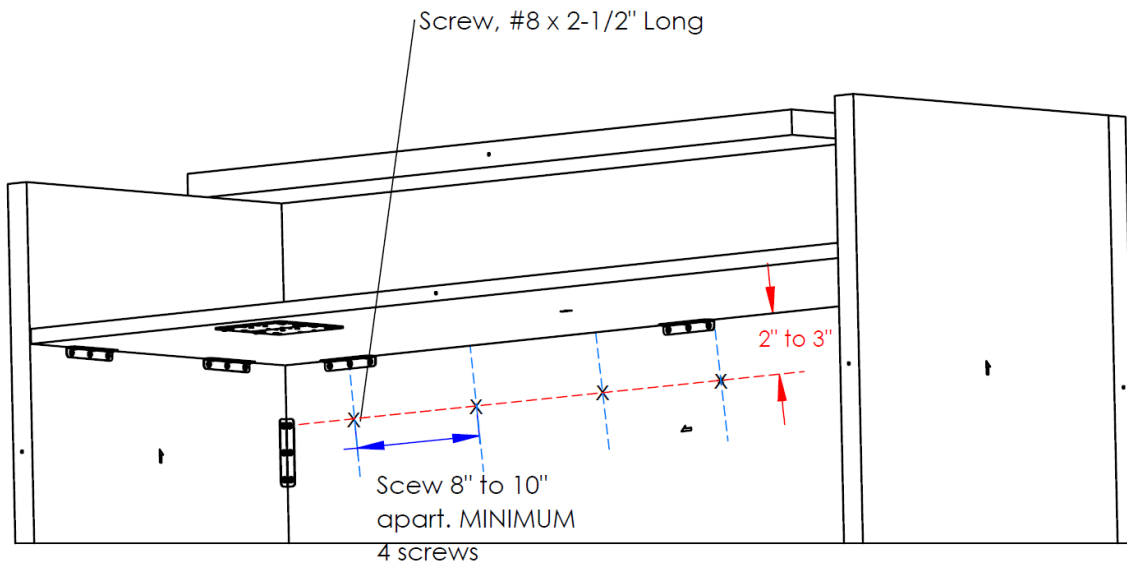

### SECTION VIEW

