



ribbon

PRICE & SPECIFICATION GUIDE

Version: 03.15.24
prices effective April 1, 2024

DeskMakers

revisions

08/09/21	Product Launch
09/01/21	Updated finishes
10/13/21	Updated pricing and product details
12/20/21	Updated pricing and finishes
03/31/22	Updated option codes
08/18/22	Added surcharge note, updated TFL sizes
12/01/22	Adjusted pricing, added storage top and end panel sizes
10/18/23	Updated finishes
03/15/24	Updated pricing

table of contents

Laminates	4-6
Pulls	7
CASEGOODS	
Product Details	8-13
Desks	14-23
Returns	24-27
Bridges	28
Credenzas	29-30
Modesty Panels	31
Storage Credenzas	32-43
Support Pedestals	44-46
Storage Towers	47-49
Wall Mounted Overheads	50-51
CONFERENCE TABLES	
Product Details	52-55
Table Tops	56-60
Conference Table Base Sets	61
Electrical	62-63
Terms and conditions	64
Warranty	65

laminates finishes

standard thermofuse laminate (TFL)

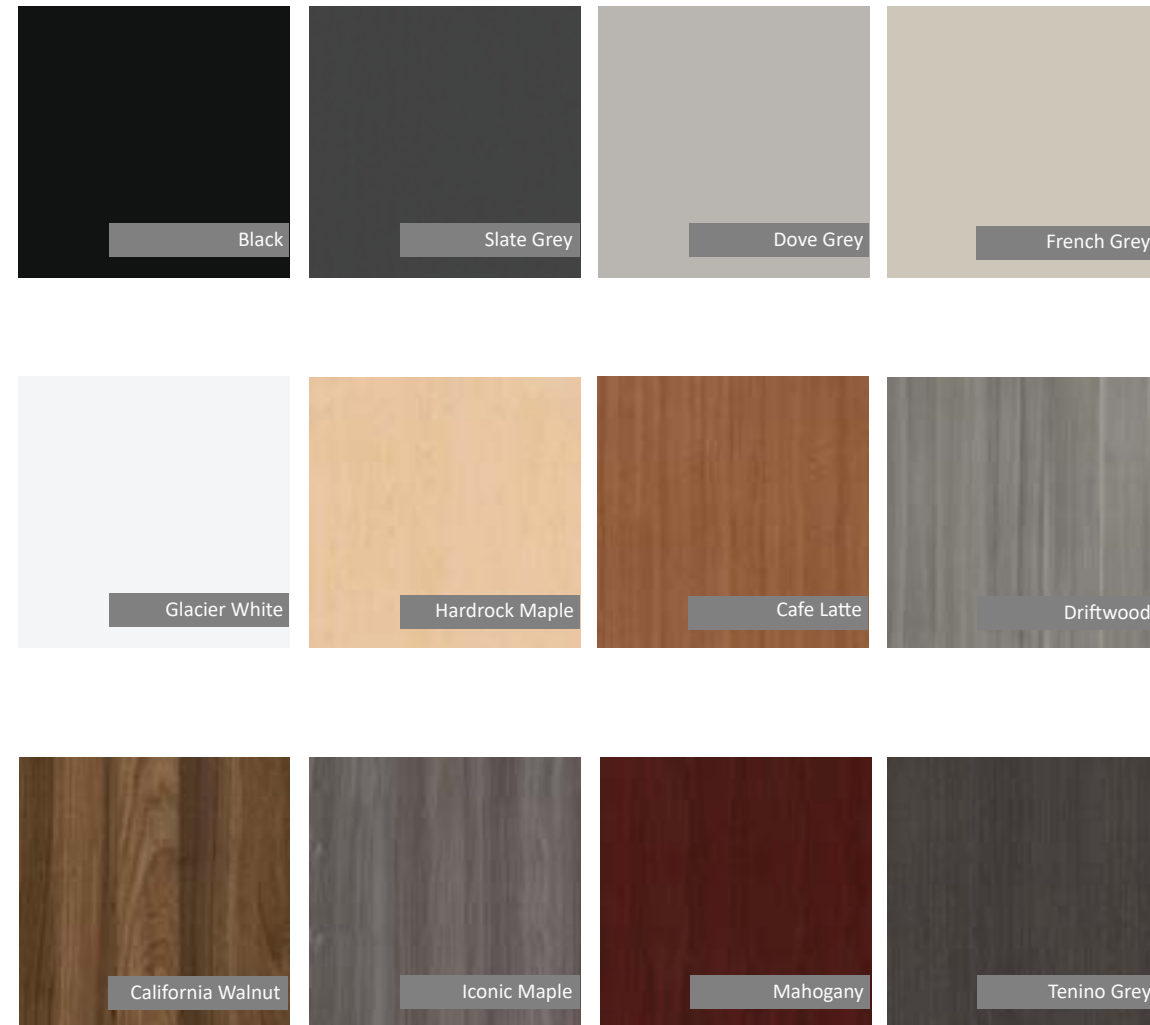

Matching 2MM PVC edgebanding is available for all Standard TFL finishes shown here.
For HPL match information please visit deskmakers.com/resources/materials

premium thermofuse laminate (TFL)

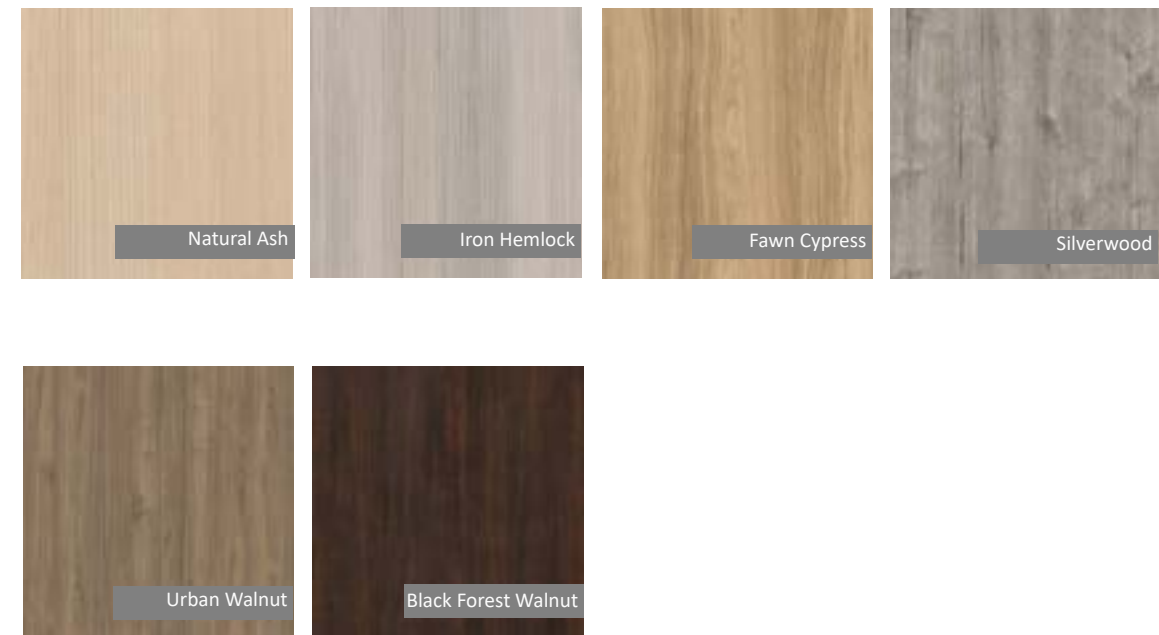

Premium TFLs require a 10% upcharge. Add item code OP-TTFL-1.
Matching 2MM PVC edgebanding is available for all Premium TFL finishes shown here.
For HPL match information please visit deskmakers.com/resources/materials

laminates finishes

high pressure laminate (HPL)

Pricing shown in this price list applies only to non-premium HPLs as follows:

- Wilsonart: Solids, Woodgrains, and Abstracts in Matte (-60) finish,
- Formica: Color Portfolio, Woodgrains, and Patterns in Matte (-58) finish
- Pionite: Solids, Woodgrains, and Abstracts in Suede (N) finish
- Arborite: Solids, Woodgrains, Textures and Abstracts in Matte (CA) finish
- Nevamar: Solids, Woodgrains, Stones and Abstracts in ARP (-T) finish

A minimum charge of \$520 net per HPL color will be applied to each order.

Call customer service for pricing for all other HPLs.

Additional lead times required for HPL orders depending on material availability and order complexity.

high pressure laminate (HPL) pricing chart

Most DeskMakers product is made of Thermofuse laminate (TFL). As such, there is an upcharge for ordering product in high pressure laminate (HPL). This upcharge varies based on the product and the size of the HPL order.

Please note that only the portion of the order in HPL will be calculated to determine the level of HPL upcharges.

HPL is always available with DeskMakers standard 2MM edgebanding. Special order matching PVC 2MM edgebanding may be available for orders \$25,000 List or larger, call customer service for pricing.

Product Category	Option Code	HPL UPCHARGE
WORKSURFACES All Shapes <i>Top surface HPL</i>	OP-HPL1-25-??	60%
CASEGOODS Top HPL only, balance TFL	OP-HPL1-1-??	25%
CASEGOODS Entire Unit HPL	OP-HPL1-4-??	120%
CASEGOODS HPL Drawer Fronts only	OP-HPL1-2-??	20%
CASEGOODS Top HPL and HPL Drawer Fronts	OP-HPL1-3-??	30%

pulls

standard pulls

Pulls are included on all drawers and cabinet doors for no upcharge.



101SN



101BL



105SN



115SN



115BL



201SN



125SN*



125BL*



201BL

*The 125SN/BL pull is 7.5" long. On lateral file drawers and larger cabinet doors a longer 12.5" pull in the same style will be used. This may be identified as a "127SN/BL" pull on your acknowledgment.

ribbon pull

The Ribbon pull is available for no upcharge on the Ribbon Collection.



315SN



315BL

Ribbon Collection

freestanding desk



The freestanding Ribbon desk is available with both the classic Ribbon and hairpin leg style. The rectangular top shape can connect to returns or bridges to form L or U shape configurations.

cantilevering desk



The cantilevering desk style is supported on one side by low storage and can be used to create multi-level solutions.

conference tables



The classic Ribbon leg can be used to support conference tables from 72"-240".

small tables and storage



The hairpin Ribbon leg is well suited for smaller tables, and Ribbon storage options allow for a consistent style across the entire office.

Worksurfaces

finishes

1-1/8" thick thermally fused laminate (TFL) with multiple edge options
 1-1/8" thick high pressure laminate (HPL) with multiple edge options

grain direction

desk and credenza tops

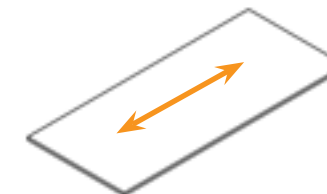

all size tops

return and bridge tops

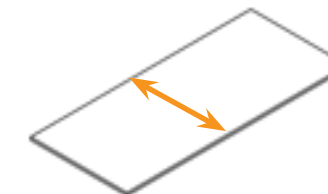

24" to 60" tops

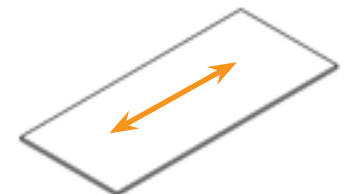

tops over 60"

rounded corners

All Ribbon top styles are made in both 90 degree and 4" radius rounded corner styles. Both straight and rounded corners will feature 2mm PVC edgebanding.

grommet locations

Ribbon grommet locations will vary according to how each top is supported. Not all locations are available on all tops. All dimensions are to center. Please note Ribbon has collection specific grommet codes.

Desk and Credenza Tops

Wedge Tops

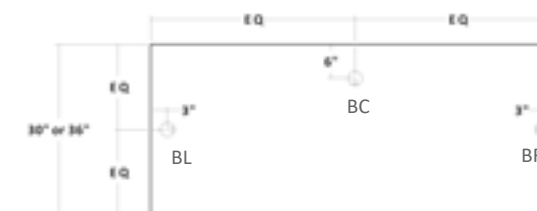

Storage Tops



configurations

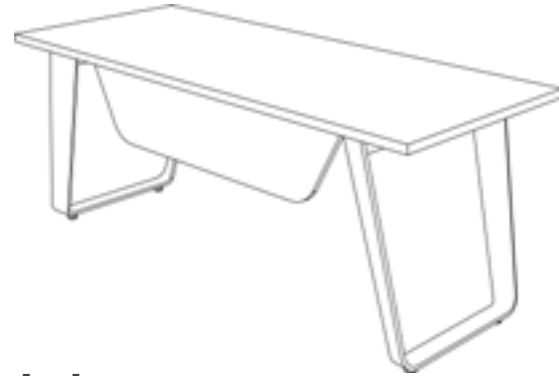

desk



hairpin desk



no storage configurations

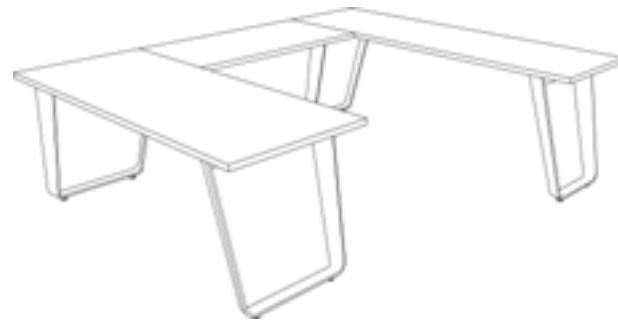

full height pedestal storage



cantilevering desks

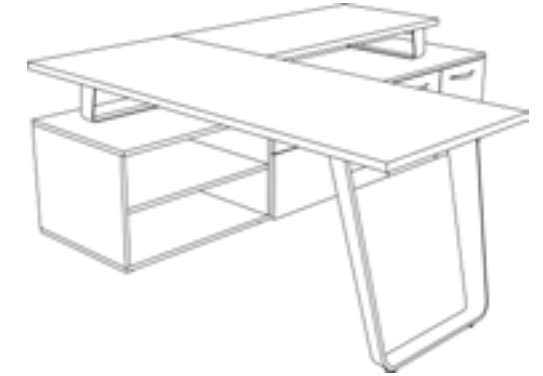

u-shape configurations

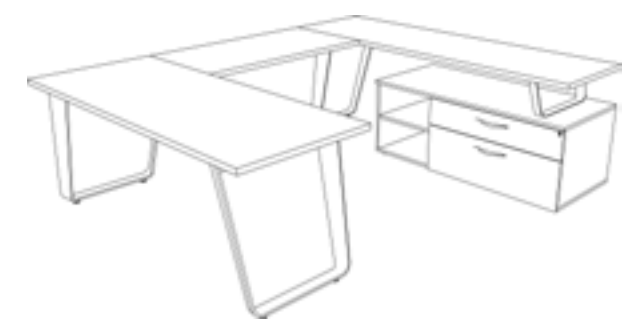

multi-desk solutions



Low Storage Credenza Configurations

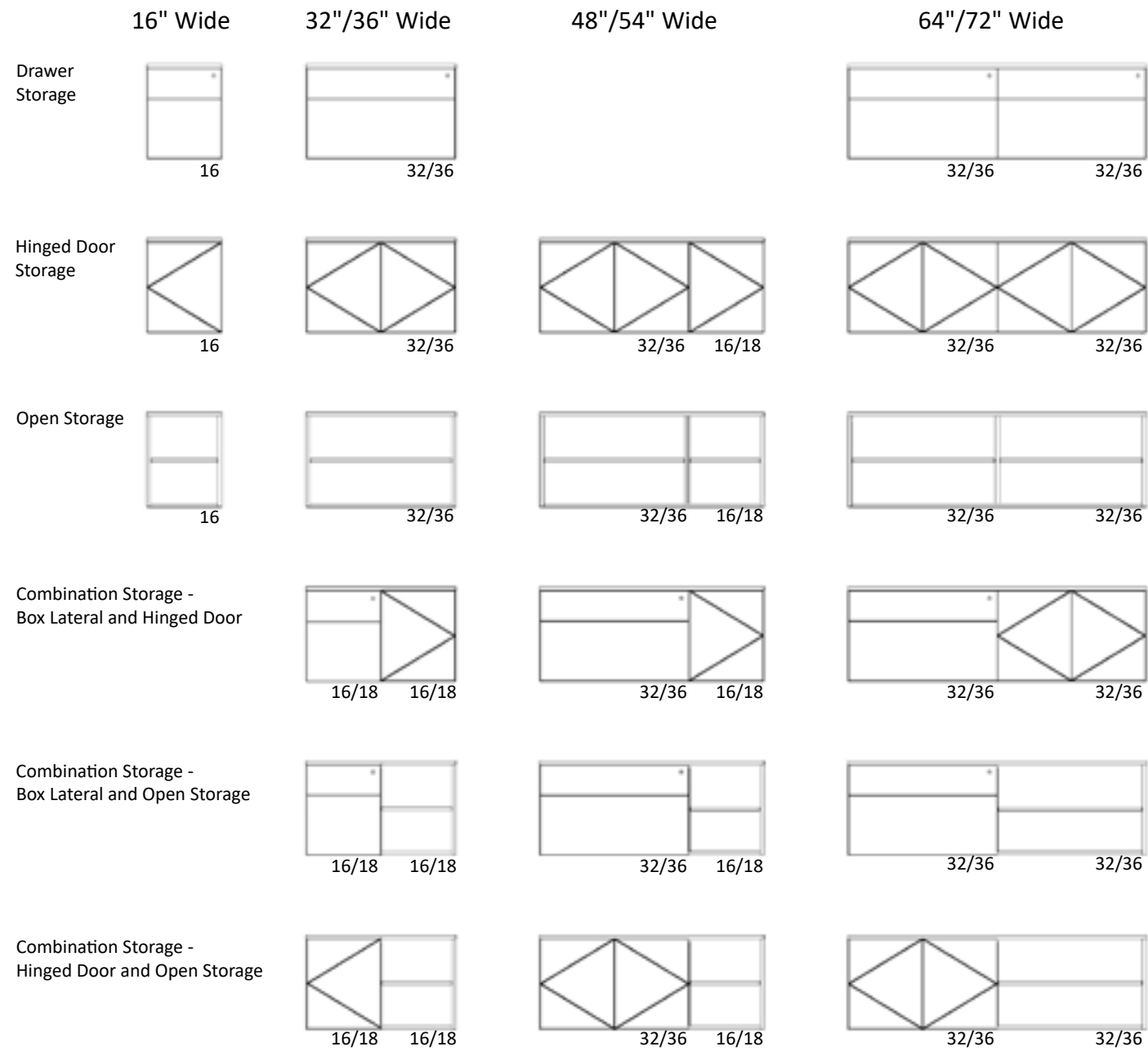

- All cabinets with left and right models are shown as left models.

Storage Finishes and Grain Direction

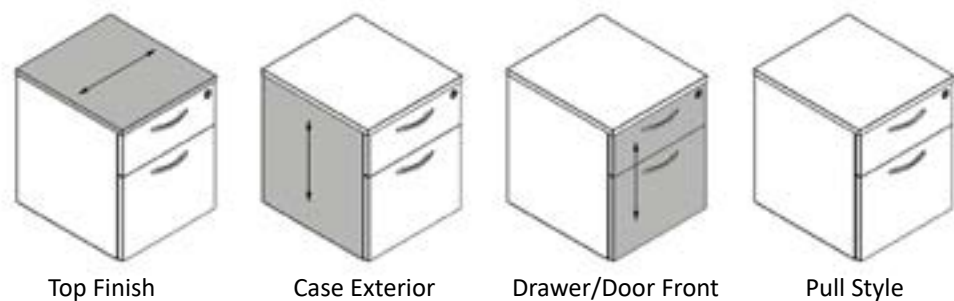

Ribbon Leg Details

- Metal open frame support legs are sold as sets with spanning rods with desk top.
- Hairpin legs are sold as sets with desk top, or as sets of 4 to be paired with table top on pg 63.
- Legs are constructed of 1/2" thick x 2-1/2" deep steel frame with a powdercoat finish.
- Spanning rods are approximately 1" square steel with a silver powdercoat finish.
- Includes leveling glides. Levelers will add 3/4" in height.
- Ribbon legs are designed to fit desks, returns, and credenzas 24" wide, 30" wide & 36" wide.
- Legs available in metallic silver, black or white powdercoat.
- Made in America

Hairpin Legs

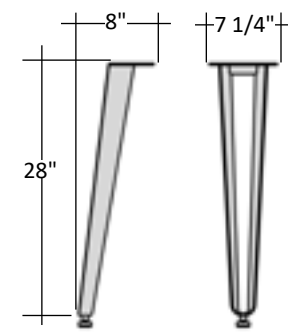

Open Frame Leg For Desks and Tables

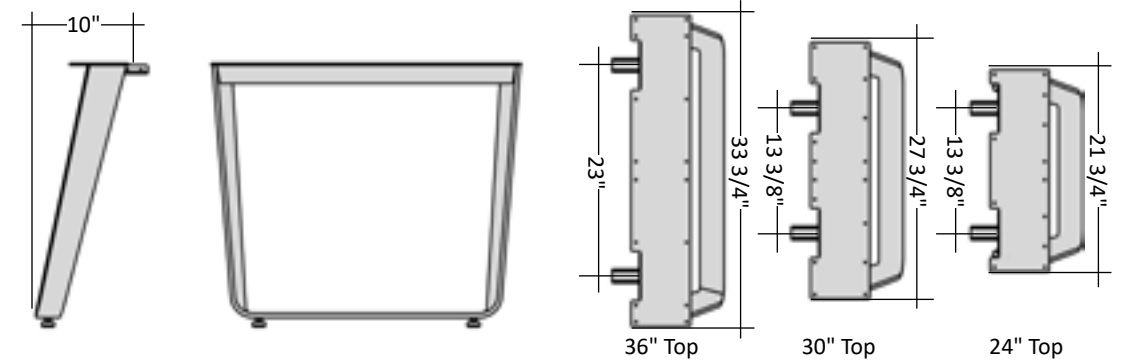

Open Frame Legs For Storage



- Ribbon storage legs are designed to fit 24" deep storage units. Units wider than 36" will have a center support leg which is narrower than the end support legs.
- All legs for storage include leveling glides. Levelers will add 3/4" in height.
- Cantilever legs will mount between desktop and low storage credenzas. These legs will bolt in place to prevent movement of the desk. See Ribbon Install Instructions for more information.

Open Frame Cantilever Leg

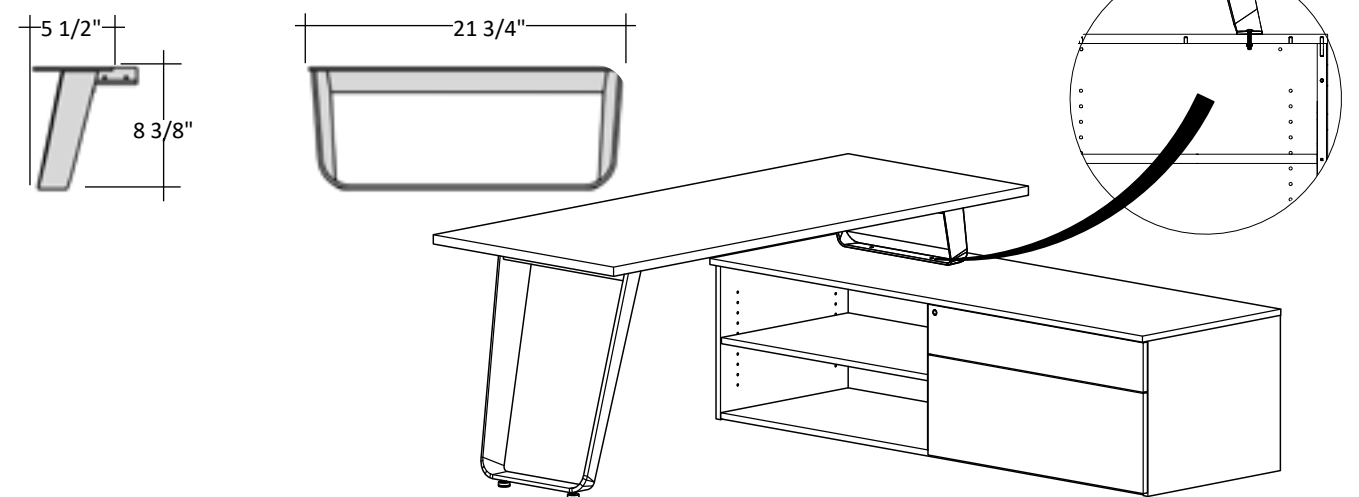

loop leg freestanding desk
rectangular worksurface



Model Number	Depth	Length	Height	TFL		HPL
				1-1/8" Thick Standard TFL 2mm PVC	1-1/8" Thick Premium TFL 2mm PVC	1-1/8" Thick Standard HPL 2mm PVC
				T1-A1	T2-A1	H1-A1
24" Deep						
RB-DFS1-2460-??-??-??	24	60	29	\$4,119	\$4,156	\$4,371
RB-DFS1-2466-??-??-??	24	66	29	\$4,138	\$4,175	\$4,390
RB-DFS1-2472-??-??-??	24	72	29	\$4,147	\$4,185	\$4,398
RB-DFS1-2478-??-??-??	24	78	29	\$4,254	\$4,299	\$4,584
RB-DFS1-2484-??-??-??	24	84	29	\$4,283	\$4,329	\$4,613
30" Deep						
RB-DFS1-3060-??-??-??	30	60	29	\$4,597	\$4,647	\$4,963
RB-DFS1-3066-??-??-??	30	66	29	\$4,614	\$4,664	\$4,982
RB-DFS1-3072-??-??-??	30	72	29	\$4,622	\$4,672	\$4,991
RB-DFS1-3078-??-??-??	30	78	29	\$4,774	\$4,837	\$5,260
RB-DFS1-3084-??-??-??	30	84	29	\$4,802	\$4,866	\$5,288
36" Deep						
RB-DFS1-3660-??-??-??	36	60	29	\$4,598	\$4,648	\$4,966
RB-DFS1-3666-??-??-??	36	66	29	\$4,616	\$4,666	\$4,985
RB-DFS1-3672-??-??-??	36	72	29	\$4,624	\$4,675	\$4,995
RB-DFS1-3678-??-??-??	36	78	29	\$4,776	\$4,840	\$5,262
RB-DFS1-3684-??-??-??	36	84	29	\$4,804	\$4,868	\$5,291

- TFL and HPL tops with 2mm PVC edges are only available with DeskMakers standard 2MM PVC edgebanding.
- Includes leveling glides.
- Legs are constructed of solid steel frame with a powdercoat finish.
- Includes spanning rods. Spanning rods are approximately 1" square steel with a powdercoat finish.
- To order, replace the first "??-??" with "T1-A1" for standard TFL, "T2-A1" for premium TFL, "H1-A1" for standard HPL and the last "??" with "SV" for silver. "BK" for black and "WT" for white finish.



loop leg freestanding desk
rounded corner rectangular worksurface



Model Number	Depth	Length	Height	TFL		HPL
				1-1/8" Thick Standard TFL 2mm PVC	1-1/8" Thick Premium TFL 2mm PVC	1-1/8" Thick Standard HPL 2mm PVC
				T1-A1	T2-A1	H1-A1
24" Deep						
RB-DFS2-2460-??-??-??	24	60	29	\$4,290	\$4,344	\$4,552
RB-DFS2-2466-??-??-??	24	66	29	\$4,309	\$4,363	\$4,571
RB-DFS2-2472-??-??-??	24	72	29	\$4,318	\$4,373	\$4,579
RB-DFS2-2478-??-??-??	24	78	29	\$4,428	\$4,491	\$4,772
RB-DFS2-2484-??-??-??	24	84	29	\$4,457	\$4,521	\$4,801
30" Deep						
RB-DFS2-3060-??-??-??	30	60	29	\$4,773	\$4,840	\$5,154
RB-DFS2-3066-??-??-??	30	66	29	\$4,790	\$4,857	\$5,173
RB-DFS2-3072-??-??-??	30	72	29	\$4,798	\$4,866	\$5,182
RB-DFS2-3078-??-??-??	30	78	29	\$4,955	\$5,037	\$5,461
RB-DFS2-3084-??-??-??	30	84	29	\$4,984	\$5,065	\$5,489
36" Deep						
RB-DFS2-3660-??-??-??	36	60	29	\$4,774	\$4,841	\$5,157
RB-DFS2-3666-??-??-??	36	66	29	\$4,792	\$4,860	\$5,176
RB-DFS2-3672-??-??-??	36	72	29	\$4,800	\$4,868	\$5,185
RB-DFS2-3678-??-??-??	36	78	29	\$4,958	\$5,039	\$5,463
RB-DFS2-3684-??-??-??	36	84	29	\$4,986	\$5,067	\$5,492

- TFL and HPL tops with 2mm PVC edges are only available with DeskMakers standard 2MM PVC edgebanding.
- Corners are rounded with a 4" radius and cannot connect to another top.
- Includes leveling glides.
- Legs are constructed of solid steel frame with a powdercoat finish.
- Includes spanning rods. Spanning rods are approximately 1" square steel with a powdercoat finish.
- To order, replace the first "??-??" with "T1-A1" for standard TFL, "T2-A1" for premium TFL, "H1-A1" for standard HPL and the last "??" with "SV" for silver. "BK" for black and "WT" for white finish.



hairpin leg freestanding desk
rectangular worksurface



Model Number	Depth	Length	Height	TFL		HPL
				1-1/8" Thick Standard TFL 2mm PVC	1-1/8" Thick Premium TFL 2mm PVC	1-1/8" Thick Standard HPL 2mm PVC
				T1-A1	T2-A1	H1-A1
24" Deep						
RB-DFS3-2460-??-??-??	24	60	29	\$4,175	\$4,212	\$4,427
RB-DFS3-2466-??-??-??	24	66	29	\$4,194	\$4,231	\$4,430
RB-DFS3-2472-??-??-??	24	72	29	\$4,203	\$4,241	\$4,454
RB-DFS3-2478-??-??-??	24	78	29	\$4,310	\$4,355	\$4,640
RB-DFS3-2484-??-??-??	24	84	29	\$4,339	\$4,385	\$4,669
30" Deep						
RB-DFS3-3060-??-??-??	30	60	29	\$4,305	\$4,355	\$4,671
RB-DFS3-3066-??-??-??	30	66	29	\$4,322	\$4,372	\$4,690
RB-DFS3-3072-??-??-??	30	72	29	\$4,330	\$4,380	\$4,699
RB-DFS3-3078-??-??-??	30	78	29	\$4,482	\$4,545	\$4,968
RB-DFS3-3084-??-??-??	30	84	29	\$4,510	\$4,574	\$4,996
36" Deep						
RB-DFS3-3660-??-??-??	36	60	29	\$4,306	\$4,356	\$4,674
RB-DFS3-3666-??-??-??	36	66	29	\$4,324	\$4,374	\$4,693
RB-DFS3-3672-??-??-??	36	72	29	\$4,332	\$4,383	\$4,703
RB-DFS3-3678-??-??-??	36	78	29	\$4,484	\$4,548	\$4,970
RB-DFS3-3684-??-??-??	36	84	29	\$4,512	\$4,576	\$4,999

- TFL and HPL tops with 2mm PVC edges are only available with DeskMakers standard 2MM PVC edgebanding.
- Includes leveling glides.
- Legs are constructed of solid steel frame with a powdercoat finish.
- Includes spanning rods. Spanning rods are approximately 1" square steel with a powdercoat finish.
- To order, replace the first "??-??" with "T1-A1" for standard TFL, "T2-A1" for premium TFL, "H1-A1" for standard HPL and the last "??" with "SV" for silver. "BK" for black and "WT" for white finish.



hairpin leg freestanding desk
rounded corner rectangular worksurface



Model Number	Depth	Length	Height	TFL		HPL
				1-1/8" Thick Standard TFL 2mm PVC	1-1/8" Thick Premium TFL 2mm PVC	1-1/8" Thick Standard HPL 2mm PVC
				T1-A1	T2-A1	H1-A1
24" Deep						
RB-DFS4-2460-??-??-??	24	60	29	\$4,346	\$4,400	\$4,608
RB-DFS4-2466-??-??-??	24	66	29	\$4,365	\$4,419	\$4,627
RB-DFS4-2472-??-??-??	24	72	29	\$4,374	\$4,429	\$4,635
RB-DFS4-2478-??-??-??	24	78	29	\$4,484	\$4,547	\$4,828
RB-DFS4-2484-??-??-??	24	84	29	\$4,513	\$4,577	\$4,857
30" Deep						
RB-DFS4-3060-??-??-??	30	60	29	\$4,481	\$4,548	\$4,862
RB-DFS4-3066-??-??-??	30	66	29	\$4,498	\$4,565	\$4,881
RB-DFS4-3072-??-??-??	30	72	29	\$4,506	\$4,574	\$4,890
RB-DFS4-3078-??-??-??	30	78	29	\$4,663	\$4,745	\$5,169
RB-DFS4-3084-??-??-??	30	84	29	\$4,692	\$4,773	\$5,197
36" Deep						
RB-DFS4-3660-??-??-??	36	60	29	\$4,482	\$4,549	\$4,865
RB-DFS4-3666-??-??-??	36	66	29	\$4,500	\$4,568	\$4,884
RB-DFS4-3672-??-??-??	36	72	29	\$4,508	\$4,576	\$4,893
RB-DFS4-3678-??-??-??	36	78	29	\$4,666	\$4,747	\$5,171
RB-DFS4-3684-??-??-??	36	84	29	\$4,694	\$4,775	\$5,200

- TFL and HPL tops with 2mm PVC edges are only available with DeskMakers standard 2MM PVC edgebanding.
- Corners are rounded with a 4" radius and cannot connect to another top.
- Includes leveling glides.
- Legs are constructed of solid steel frame with a powdercoat finish.
- Includes spanning rods. Spanning rods are approximately 1" square steel with a powdercoat finish.
- To order, replace the first "??-??" with "T1-A1" for standard TFL, "T2-A1" for premium TFL, "H1-A1" for standard HPL and the last "??" with "SV" for silver. "BK" for black and "WT" for white finish.



loop leg peninsula desk with riser
rectangular worksurface



Model Number	Depth	Length	Height	TFL		HPL
				1-1/8" Thick Standard TFL 2mm PVC	1-1/8" Thick Premium TFL 2mm PVC	1-1/8" Thick Standard HPL 2mm PVC
				T1-A1	T2-A1	H1-A1
24" Deep						
RB-RPS1-2460-??-??-??	24	60	29	\$2,549	\$2,586	\$2,801
RB-RPS1-2466-??-??-??	24	66	29	\$2,568	\$2,605	\$2,820
RB-RPS1-2472-??-??-??	24	72	29	\$2,577	\$2,615	\$2,828
RB-RPS1-2478-??-??-??	24	78	29	\$2,684	\$2,729	\$3,014
RB-RPS1-2484-??-??-??	24	84	29	\$2,713	\$2,759	\$3,043
30" Deep						
RB-RPS1-3060-??-??-??	30	60	29	\$2,853	\$2,903	\$3,219
RB-RPS1-3066-??-??-??	30	66	29	\$2,870	\$2,920	\$3,238
RB-RPS1-3072-??-??-??	30	72	29	\$2,878	\$2,928	\$3,247
RB-RPS1-3078-??-??-??	30	78	29	\$3,030	\$3,093	\$3,516
RB-RPS1-3084-??-??-??	30	84	29	\$3,058	\$3,122	\$3,544
36" Deep						
RB-RPS1-3660-??-??-??	36	60	29	\$2,854	\$2,904	\$3,222
RB-RPS1-3666-??-??-??	36	66	29	\$2,872	\$2,922	\$3,241
RB-RPS1-3672-??-??-??	36	72	29	\$2,880	\$2,931	\$3,251
RB-RPS1-3678-??-??-??	36	78	29	\$3,032	\$3,096	\$3,518
RB-RPS1-3684-??-??-??	36	84	29	\$3,060	\$3,124	\$3,547

- TFL and HPL tops with 2mm PVC edges are only available with DeskMakers standard 2MM PVC edgebanding.
- Includes leveling glides.
- Legs are constructed of solid steel frame with a powdercoat finish.
- Includes spanning rods. Spanning rods are approximately 1" square steel with a powdercoat finish.
- To order, replace the first "??-??" with "T1-A1" for standard TFL, "T2-A1" for premium TFL, "H1-A1" for standard HPL and the last "??" with "SV" for silver. "BK" for black and "WT" for white finish.



loop leg peninsula desk with riser
rounded corner rectangular worksurface



Model Number	Depth	Length	Height	TFL		HPL
				1-1/8" Thick Standard TFL 2mm PVC	1-1/8" Thick Premium TFL 2mm PVC	1-1/8" Thick Standard HPL 2mm PVC
				T1-A1	T2-A1	H1-A1
24" Deep						
RB-RPS2-2460-??-??-??	24	60	29	\$2,720	\$2,774	\$2,982
RB-RPS2-2466-??-??-??	24	66	29	\$2,739	\$2,793	\$3,001
RB-RPS2-2472-??-??-??	24	72	29	\$2,748	\$2,803	\$3,009
RB-RPS2-2478-??-??-??	24	78	29	\$2,858	\$2,921	\$3,202
RB-RPS2-2484-??-??-??	24	84	29	\$2,887	\$2,951	\$3,231
30" Deep						
RB-RPS2-3060-??-??-??	30	60	29	\$3,029	\$3,096	\$3,410
RB-RPS2-3066-??-??-??	30	66	29	\$3,046	\$3,113	\$3,429
RB-RPS2-3072-??-??-??	30	72	29	\$3,054	\$3,122	\$3,438
RB-RPS2-3078-??-??-??	30	78	29	\$3,211	\$3,293	\$3,717
RB-RPS2-3084-??-??-??	30	84	29	\$3,240	\$3,321	\$3,745
36" Deep						
RB-RPS2-3660-??-??-??	36	60	29	\$3,030	\$3,097	\$3,413
RB-RPS2-3666-??-??-??	36	66	29	\$3,048	\$3,116	\$3,432
RB-RPS2-3672-??-??-??	36	72	29	\$3,056	\$3,124	\$3,441
RB-RPS2-3678-??-??-??	36	78	29	\$3,214	\$3,295	\$3,719
RB-RPS2-3684-??-??-??	36	84	29	\$3,242	\$3,323	\$3,748

- TFL and HPL tops with 2mm PVC edges are only available with DeskMakers standard 2MM PVC edgebanding.
- Corners are rounded with a 4" radius and cannot connect to another top.
- Includes leveling glides.
- Legs are constructed of solid steel frame with a powdercoat finish.
- Includes spanning rods. Spanning rods are approximately 1" square steel with a powdercoat finish.
- To order, replace the first "??-??" with "T1-A1" for standard TFL, "T2-A1" for premium TFL, "H1-A1" for standard HPL and the last "??" with "SV" for silver. "BK" for black and "WT" for white finish.



loop leg peninsula desk with riser
wedge worksurface



Model Number	Depth	Length	Height	TFL		HPL	
				1-1/8" Thick Standard TFL 2mm PVC	1-1/8" Thick Premium TFL 2mm PVC	1-1/8" Thick Standard HPL 2mm PVC	
				T1-A1	T2-A1	H1-A1	
30" Deep							
Left Model	Right Model						
RB-WPS1-3060-L-??-??-??	RB-WPS1-3060-R-??-??-??	24/30	60	29	\$2,956	\$3,016	\$3,365
RB-WPS1-3066-L-??-??-??	RB-WPS1-3066-R-??-??-??	24/30	66	29	\$3,026	\$3,092	\$3,475
RB-WPS1-3072-L-??-??-??	RB-WPS1-3072-R-??-??-??	24/30	72	29	\$3,056	\$3,124	\$3,521
RB-WPS1-3078-L-??-??-??	RB-WPS1-3078-R-??-??-??	24/30	78	29	\$3,240	\$3,324	\$3,818
RB-WPS1-3084-L-??-??-??	RB-WPS1-3084-R-??-??-??	24/30	84	29	\$3,405	\$3,503	\$4,073
36" Deep							
RB-WPS1-3660-L-??-??-??	RB-WPS1-3660-R-??-??-??	30/36	60	29	\$3,069	\$3,141	\$3,556
RB-WPS1-3666-L-??-??-??	RB-WPS1-3666-R-??-??-??	30/36	66	29	\$3,151	\$3,229	\$3,684
RB-WPS1-3672-L-??-??-??	RB-WPS1-3672-R-??-??-??	30/36	72	29	\$3,189	\$3,270	\$3,738
RB-WPS1-3678-L-??-??-??	RB-WPS1-3678-R-??-??-??	30/36	78	29	\$3,400	\$3,501	\$4,087
RB-WPS1-3684-L-??-??-??	RB-WPS1-3684-R-??-??-??	30/36	84	29	\$3,590	\$3,706	\$4,386

- TFL and HPL tops with 2mm PVC edges are only available with DeskMakers standard 2MM PVC edgebanding.
- Wedge worksurfaces cannot be connected to another top.
- Includes leveling glides.
- Legs are constructed of solid steel frame with a powdercoat finish.
- Includes spanning rods. Spanning rods are approximately 1" square steel with a powdercoat finish.
- To order, replace the first "??-??" with "T1-A1" for standard TFL, "T2-A1" for premium TFL, "H1-A1" for standard HPL and the last "??" with "SV" for silver. "BK" for black and "WT" for white finish.

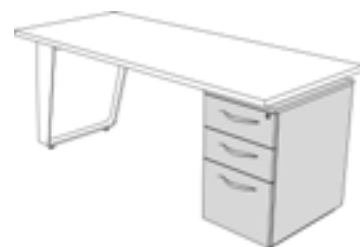

loop leg peninsula desk with riser
rounded corner wedge worksurface



Model Number	Depth	Length	Height	TFL		HPL	
				1-1/8" Thick Standard TFL 2mm PVC	1-1/8" Thick Premium TFL 2mm PVC	1-1/8" Thick Standard HPL 2mm PVC	
				T1-A1	T2-A1	H1-A1	
30" Deep							
Left Model	Right Model						
RB-WPS2-3060-L-??-??-??	RB-WPS2-3060-R-??-??-??	24/30	60	29	\$3,136	\$3,214	\$3,625
RB-WPS2-3066-L-??-??-??	RB-WPS2-3066-R-??-??-??	24/30	66	29	\$3,208	\$3,292	\$3,744
RB-WPS2-3072-L-??-??-??	RB-WPS2-3072-R-??-??-??	24/30	72	29	\$3,239	\$3,325	\$3,793
RB-WPS2-3078-L-??-??-??	RB-WPS2-3078-R-??-??-??	24/30	78	29	\$3,430	\$3,533	\$4,116
RB-WPS2-3084-L-??-??-??	RB-WPS2-3084-R-??-??-??	24/30	84	29	\$3,600	\$3,717	\$4,394
36" Deep							
RB-WPS2-3660-L-??-??-??	RB-WPS2-3660-R-??-??-??	30/36	60	29	\$3,254	\$3,344	\$3,834
RB-WPS2-3666-L-??-??-??	RB-WPS2-3666-R-??-??-??	30/36	66	29	\$3,338	\$3,435	\$3,973
RB-WPS2-3672-L-??-??-??	RB-WPS2-3672-R-??-??-??	30/36	72	29	\$3,378	\$3,478	\$4,031
RB-WPS2-3678-L-??-??-??	RB-WPS2-3678-R-??-??-??	30/36	78	29	\$3,596	\$3,716	\$4,411
RB-WPS2-3684-L-??-??-??	RB-WPS2-3684-R-??-??-??	30/36	84	29	\$3,792	\$3,929	\$4,736

- TFL and HPL tops with 2mm PVC edges are only available with DeskMakers standard 2MM PVC edgebanding.
- Wedge worksurfaces cannot be connected to another top.
- Includes leveling glides.
- Legs are constructed of solid steel frame with a powdercoat finish.
- Includes spanning rods. Spanning rods are approximately 1" square steel with a powdercoat finish.
- To order, replace the first "??-??" with "T1-A1" for standard TFL, "T2-A1" for premium TFL, "H1-A1" for standard HPL and the last "??" with "SV" for silver. "BK" for black and "WT" for white finish.



loop leg peninsula desk with support leg
rectangular worksurface



Model Number	Depth	Length	Height	TFL		HPL
				1-1/8" Thick Standard TFL 2mm PVC	1-1/8" Thick Premium TFL 2mm PVC	1-1/8" Thick Standard HPL 2mm PVC
				T1-A1	T2-A1	H1-A1
24" Deep						
RB-RPS3-2460-??-??-??	24	60	29	\$3,723	\$3,760	\$3,975
RB-RPS3-2466-??-??-??	24	66	29	\$3,742	\$3,779	\$3,994
RB-RPS3-2472-??-??-??	24	72	29	\$3,751	\$3,789	\$4,002
RB-RPS3-2478-??-??-??	24	78	29	\$3,858	\$3,903	\$4,188
RB-RPS3-2484-??-??-??	24	84	29	\$3,887	\$3,933	\$4,217
30" Deep						
RB-RPS3-3060-??-??-??	30	60	29	\$4,027	\$4,077	\$4,393
RB-RPS3-3066-??-??-??	30	66	29	\$4,044	\$4,094	\$4,412
RB-RPS3-3072-??-??-??	30	72	29	\$4,052	\$4,102	\$4,421
RB-RPS3-3078-??-??-??	30	78	29	\$4,204	\$4,267	\$4,690
RB-RPS3-3084-??-??-??	30	84	29	\$4,232	\$4,296	\$4,718
36" Deep						
RB-RPS3-3660-??-??-??	36	60	29	\$4,028	\$4,078	\$4,396
RB-RPS3-3666-??-??-??	36	66	29	\$4,046	\$4,096	\$4,415
RB-RPS3-3672-??-??-??	36	72	29	\$4,054	\$4,105	\$4,425
RB-RPS3-3678-??-??-??	36	78	29	\$4,206	\$4,270	\$4,692
RB-RPS3-3684-??-??-??	36	84	29	\$4,234	\$4,298	\$4,721

- TFL and HPL tops with 2mm PVC edges are only available with DeskMakers standard 2MM PVC edgebanding.
- Includes leveling glides.
- Legs are constructed of solid steel frame with a powdercoat finish.
- Includes spanning rods. Spanning rods are approximately 1" square steel with a powdercoat finish.
- To order, replace the first "??-??" with "T1-A1" for standard TFL, "T2-A1" for premium TFL, "H1-A1" for standard HPL and the last "??" with "SV" for silver. "BK" for black and "WT" for white finish.

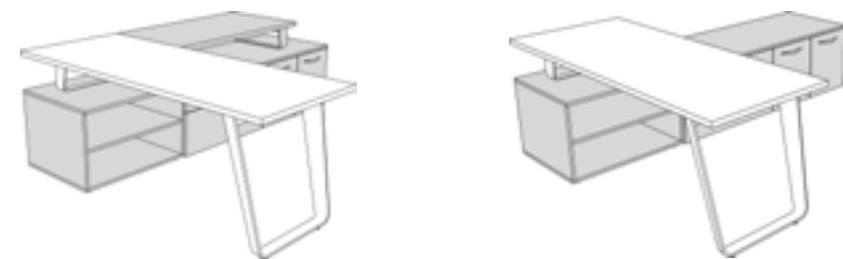

loop leg peninsula desk with support leg
rounded corner rectangular worksurface



Model Number	Depth	Length	Height	TFL		HPL
				1-1/8" Thick Standard TFL 2mm PVC	1-1/8" Thick Premium TFL 2mm PVC	1-1/8" Thick Standard HPL 2mm PVC
				T1-A1	T2-A1	H1-A1
24" Deep						
RB-RPS4-2460-??-??-??	24	60	29	\$3,894	\$3,948	\$4,156
RB-RPS4-2466-??-??-??	24	66	29	\$3,913	\$3,967	\$4,175
RB-RPS4-2472-??-??-??	24	72	29	\$3,922	\$3,977	\$4,183
RB-RPS4-2478-??-??-??	24	78	29	\$4,032	\$4,095	\$4,376
RB-RPS4-2484-??-??-??	24	84	29	\$4,061	\$4,125	\$4,405
30" Deep						
RB-RPS4-3060-??-??-??	30	60	29	\$4,203	\$4,270	\$4,584
RB-RPS4-3066-??-??-??	30	66	29	\$4,220	\$4,287	\$4,603
RB-RPS4-3072-??-??-??	30	72	29	\$4,228	\$4,296	\$4,612
RB-RPS4-3078-??-??-??	30	78	29	\$4,385	\$4,467	\$4,891
RB-RPS4-3084-??-??-??	30	84	29	\$4,414	\$4,495	\$4,919
36" Deep						
RB-RPS4-3660-??-??-??	36	60	29	\$4,204	\$4,271	\$4,587
RB-RPS4-3666-??-??-??	36	66	29	\$4,222	\$4,290	\$4,606
RB-RPS4-3672-??-??-??	36	72	29	\$4,230	\$4,298	\$4,615
RB-RPS4-3678-??-??-??	36	78	29	\$4,388	\$4,469	\$4,893
RB-RPS4-3684-??-??-??	36	84	29	\$4,416	\$4,497	\$4,922

- TFL and HPL tops with 2mm PVC edges are only available with DeskMakers standard 2MM PVC edgebanding.
- Corners are rounded with a 4" radius and cannot connect to another top.
- Includes leveling glides.
- Legs are constructed of solid steel frame with a powdercoat finish.
- Includes spanning rods. Spanning rods are approximately 1" square steel with a powdercoat finish.
- To order, replace the first "??-??" with "T1-A1" for standard TFL, "T2-A1" for premium TFL, "H1-A1" for standard HPL and the last "??" with "SV" for silver. "BK" for black and "WT" for white finish.

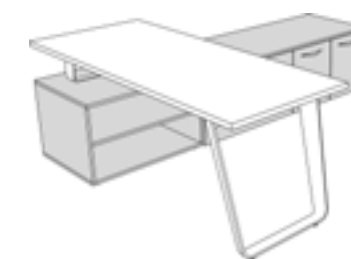

storage top with full riser

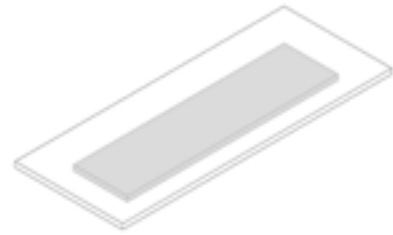

Model Number	Depth	Length	Height	TFL		HPL
				1-1/8" Thick Standard TFL 2mm PVC	1-1/8" Thick Premium TFL 2mm PVC	1-1/8" Thick Standard HPL 2mm PVC
				T1-A1	T2-A1	H1-A1
RB-STFR-2416-??-??	24	16	2 1/4	\$229	\$252	\$385
RB-STFR-2432-??-??	24	32	2 1/4	\$424	\$467	\$715
RB-STFR-2436-??-??	24	36	2 1/4	\$433	\$476	\$728
RB-STFR-2442-??-??	24	42	2 1/4	\$498	\$548	\$839
RB-STFR-2448-??-??	24	48	2 1/4	\$546	\$600	\$918
RB-STFR-2454-??-??	24	54	2 1/4	\$590	\$649	\$990
RB-STFR-2460-??-??	24	60	2 1/4	\$620	\$682	\$1,042
RB-STFR-2464-??-??	24	64	2 1/4	\$649	\$714	\$1,094
RB-STFR-2466-??-??	24	66	2 1/4	\$660	\$726	\$1,154
RB-STFR-2472-??-??	24	72	2 1/4	\$720	\$792	\$1,212
RB-STFR-2478-??-??	24	78	2 1/4	\$824	\$906	\$1,387
RB-STFR-2484-??-??	24	84	2 1/4	\$856	\$941	\$1,440

- TFL and HPL tops with 2mm PVC edges are only available with DeskMakers standard 2MM PVC edgebanding.
- Can be used as a return, or paired with end panel to form a credenza. 48" or less of span can be unsupported by storage.
- To order, replace "??-??" with "T1-A1" for standard TFL, "T2-A1" for premium TFL, or "H1-A1" for standard HPL.

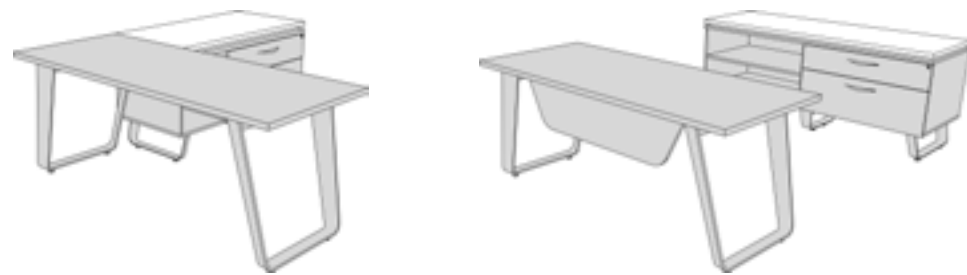

end panel

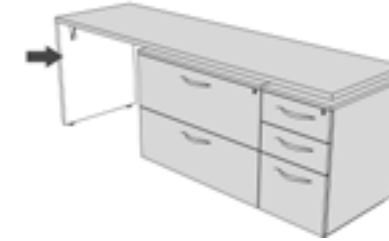

Model Number	Depth	Height	TFL		HPL
			1-1/8" Thick Standard TFL 2mm PVC	1-1/8" Thick Premium TFL 2mm PVC	1-1/8" Thick Standard HPL 2mm PVC
			T1-A1	T2-A1	H1-A1
RB-EPL1-24-??	24	28	\$303	\$333	\$558

- TFL and HPL end panels with 2mm PVC edges are only available with DeskMakers standard 2MM PVC edgebanding.
- Can be paired with storage top to form a credenza.
- To order, replace "??-??" with "T1-A1" for standard TFL, "T2-A1" for premium TFL, or "H1-A1" for standard HPL.

short end panel

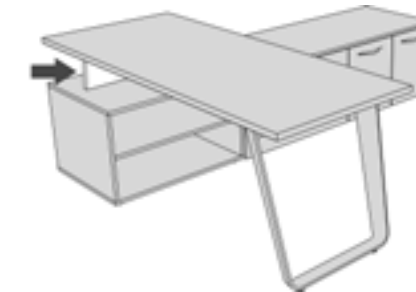
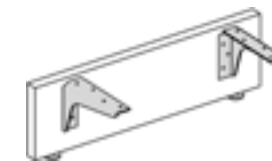

Model Number	Depth	Height	TFL		HPL
			1-1/8" Thick Standard TFL 2mm PVC	1-1/8" Thick Premium TFL 2mm PVC	1-1/8" Thick Standard HPL 2mm PVC
			T1-A1	T2-A1	H1-A1
RB-EPL2-24-??	24	8	\$152	\$167	\$279

- TFL and HPL end panels with 2mm PVC edges are only available with DeskMakers standard 2MM PVC edgebanding.
- Can be used to support a top off a low credenza storage unit.
- To order, replace "??-??" with "T1-A1" for standard TFL, "T2-A1" for premium TFL, or "H1-A1" for standard HPL.

loop leg return



Model Number	Depth	Length	Height	TFL		HPL
				1-1/8" Thick Standard TFL 2mm PVC	1-1/8" Thick Premium TFL 2mm PVC	1-1/8" Thick Standard HPL 2mm PVC
				T1-A1	T2-A1	H1-A1
RB-RTLG-2442-??-??-??	24	42	29	\$2,317	\$2,344	\$2,485
RB-RTLG-2448-??-??-??	24	48	29	\$2,432	\$2,468	\$2,682
RB-RTLG-2454-??-??-??	24	54	29	\$2,457	\$2,494	\$2,709
RB-RTLG-2460-??-??-??	24	60	29	\$2,467	\$2,504	\$2,719
RB-RTLG-2466-??-??-??	24	66	29	\$2,480	\$2,517	\$2,732
RB-RTLG-2472-??-??-??	24	72	29	\$2,515	\$2,553	\$2,766

- TFL and HPL tops with 2mm PVC edges are only available with DeskMakers standard 2MM PVC edgebanding.
- Full height leg includes leveling glides. Short leg must be attached to low storage unit at install
- Legs are constructed of solid steel frame with a powdercoat finish. Spanning rods are approximately 1" square steel with a powdercoat finish.
- To order, replace the first "??-??" with "T1-A1" for standard TFL, "T2-A1" for premium TFL, "H1-A1" for standard HPL and the last "??" with "SV" for silver. "BK" for black and "WT" for white finish.



short leg return



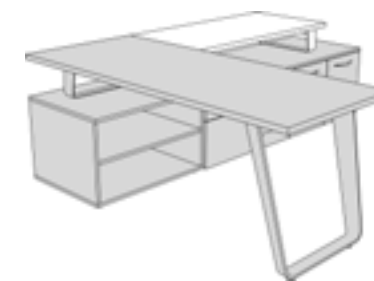

Model Number	Depth	Length	Height	TFL		HPL
				1-1/8" Thick Standard TFL 2mm PVC	1-1/8" Thick Premium TFL 2mm PVC	1-1/8" Thick Standard HPL 2mm PVC
				T1-A1	T2-A1	H1-A1
RB-RTSL-2442-??-??-??	24	42	8	\$1,922	\$1,949	\$2,090
RB-RTSL-2448-??-??-??	24	48	8	\$2,037	\$2,073	\$2,287
RB-RTSL-2454-??-??-??	24	54	8	\$2,062	\$2,099	\$2,314
RB-RTSL-2460-??-??-??	24	60	8	\$2,072	\$2,109	\$2,324
RB-RTSL-2466-??-??-??	24	66	8	\$2,085	\$2,122	\$2,337
RB-RTSL-2472-??-??-??	24	72	8	\$2,120	\$2,158	\$2,371

- TFL and HPL tops with 2mm PVC edges are only available with DeskMakers standard 2MM PVC edgebanding.
- Full height leg includes leveling glides. Short leg must be attached to low storage unit at install
- Legs are constructed of solid steel frame with a powdercoat finish. Spanning rods are approximately 1" square steel with a powdercoat finish.
- To order, replace the first "??-??" with "T1-A1" for standard TFL, "T2-A1" for premium TFL, "H1-A1" for standard HPL and the last "??" with "SV" for silver. "BK" for black and "WT" for white finish.



bridge worksurface

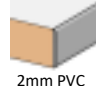
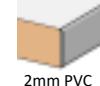

TFL		HPL
1-1/8" Thick Standard TFL  2mm PVC	1-1/8" Thick Premium TFL  2mm PVC	1-1/8" Thick Standard HPL  2mm PVC
T1-A1	T2-A1	H1-A1

Model Number	Depth	Length	Height
RB-BRDG-2442-??-??	24	42	1 1/8
RB-BRDG-2448-??-??	24	48	1 1/8
RB-BRDG-2454-??-??	24	54	1 1/8
RB-BRDG-2460-??-??	24	60	1 1/8

- TFL and HPL tops with 2mm PVC edges are only available with DeskMakers standard 2MM PVC edgebanding.
- Includes spanning rods. Spanning rods are approximately 1" square steel with a powdercoat finish.
- To order, replace "??-??" with "T1-A1" for standard TFL, "T2-A1" for premium TFL, or "H1-A1" for standard HPL.



loop leg credenza with riser

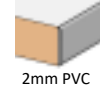
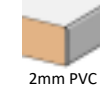
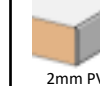

TFL		HPL
1-1/8" Thick Standard TFL  2mm PVC	1-1/8" Thick Premium TFL  2mm PVC	1-1/8" Thick Standard HPL  2mm PVC
T1-A1	T2-A1	H1-A1

Model Number	Depth	Length	Height	T1-A1	T2-A1	H1-A1
RB-CRLR-2460-??-??-??	24	60	29	\$2,380	\$2,442	\$2,802
RB-CRLR-2466-??-??-??	24	66	29	\$2,420	\$2,486	\$2,914
RB-CRLR-2472-??-??-??	24	72	29	\$2,480	\$2,552	\$2,972
RB-CRLR-2478-??-??-??	24	78	29	\$2,584	\$2,666	\$3,147
RB-CRLR-2484-??-??-??	24	84	29	\$2,616	\$2,701	\$3,200

- TFL and HPL tops with 2mm PVC edges are only available with DeskMakers standard 2MM PVC edgebanding.
- Includes leveling glides.
- Legs are constructed of solid steel frame with a powdercoat finish.
- Includes spanning rods. Spanning rods are approximately 1" square steel with a powdercoat finish.
- To order, replace the first "??-??" with "T1-A1" for standard TFL, "T2-A1" for premium TFL, "H1-A1" for standard HPL and the last "??" with "SV" for silver. "BK" for black and "WT" for white finish.



short leg credenza



Model Number	Depth	Length	Height	TFL		HPL
				1-1/8" Thick Standard TFL 2mm PVC	1-1/8" Thick Premium TFL 2mm PVC	1-1/8" Thick Standard HPL 2mm PVC
RB-CSL2-2448-??-??-??	24	48	8	T1-A1	T2-A1	H1-A1
RB-CSL2-2454-??-??-??	24	54	8	\$3,266	\$3,302	\$3,516
RB-CSL2-2464-??-??-??	24	64	8	\$3,283	\$3,320	\$3,535
RB-CSL2-2472-??-??-??	24	72	8	\$3,340	\$3,377	\$3,592
				\$3,355	\$3,393	\$3,606

- TFL and HPL tops with 2mm PVC edges are only available with DeskMakers standard 2MM PVC edgebanding.
- Includes leveling glides.
- Legs are constructed of solid steel frame with a powdercoat finish.
- To order, replace the first "??-??" with "T1-A1" for standard TFL, "T2-A1" for premium TFL, "H1-A1" for standard HPL and the last "??" with "SV" for silver. "BK" for black and "WT" for white finish.



ribbon modesty panel



Model Number	Length	Height	T1	T2
RB-LMD1-1240-??	40	12	\$214	\$235
RB-LMD1-1246-??	46	12	\$224	\$247
RB-LMD1-1252-??	52	12	\$234	\$257
RB-LMD1-1258-??	58	12	\$255	\$280
RB-LMD1-1264-??	64	12	\$276	\$304

- Grain runs horizontally on all modesty panels.
- Ships unattached. Includes mounting hardware.
- To order, replace "??" with "T1" for standard TFL or "T2" for premium TFL.

low credenza - box/lateral with open storage



Right Model Shown

Model Number	Width	Depth	Height	T1	T2	
Left Model	Right Model					
RB-BLBL-2432-L-??	RB-BLBL-2432-R-??	32	24	19-5/8	\$1,713	\$1,884
RB-BLBL-2436-L-??	RB-BLBL-2436-R-??	36	24	19-5/8	\$1,721	\$1,893

- Includes levelers and lock.
 - To order, replace the first "???" with "T1" for standard TFL, "T2" for premium TFL, or "H1" for standard HPL.

low credenza - box/lateral with open storage



Right Model Shown

Model Number	Width	Depth	Height	T1	T2	
Left Model	Right Model					
RB-BLBL-2448-L-??	RB-BLBL-2448-R-??	48	24	19-5/8	\$1,745	\$1,919
RB-BLBL-2454-L-??	RB-BLBL-2454-R-??	54	24	19-5/8	\$1,984	\$2,182

- Lateral file drawer allows for two rows front to back legal or letter filing, or one row of side to side legal filing.
 - Includes levelers and lock.
 - To order, replace the first "???" with "T1" for standard TFL, "T2" for premium TFL, or "H1" for standard HPL.

low credenza - box/lateral with open storage



Right Model Shown

Model Number	Width	Depth	Height	T1	T2	
Left Model	Right Model					
RB-BLBL-2464-L-??	RB-BLBL-2464-R-??	64	24	19-5/8	\$1,996	\$2,195
RB-BLBL-2472-L-??	RB-BLBL-2472-R-??	72	24	19-5/8	\$2,269	\$2,496

- Lateral file drawer allows for two rows front to back legal or letter filing, or one row of side to side legal filing.
 - Includes levelers and lock.
 - To order, replace the first "???" with "T1" for standard TFL, "T2" for premium TFL, or "H1" for standard HPL.

loop leg credenza - box/lateral with open storage



Right Model Shown

Model Number	Width	Depth	Height	T1	T2	
Left Model	Right Model					
RB-BLBC-2432-L-??-??	RB-BLBC-2432-R-??-??	32	24	26-7/8	\$4,781	\$4,952
RB-BLBC-2436-L-??-??	RB-BLBC-2436-R-??-??	36	24	26-7/8	\$4,789	\$4,961

- Height listed includes legs.
 - Includes levelers and lock.
 - To order, replace the first "???" with "T1" for standard TFL, "T2" for premium TFL, or "H1" for standard HPL and the last "???" with "SV" for silver. "BK" for black and "WT" for white finish.

loop leg credenza - box/lateral with open storage



Right Model Shown

Model Number	Width	Depth	Height	T1	T2	
Left Model	Right Model					
RB-BLBC-2448-L-??-??	RB-BLBC-2448-R-??-??	48	24	26-7/8	\$6,215	\$6,389
RB-BLBC-2454-L-??-??	RB-BLBC-2454-R-??-??	54	24	26-7/8	\$6,454	\$6,652

- Height listed includes legs. Storage credenzas over 36" wide have a recessed middle leg.
 - Adjustable internal bars allow for two rows front-to-back, letter or legal size hanging files.
 - Includes levelers and lock.
 - To order, replace the first "???" with "T1" for standard TFL, "T2" for premium TFL, or "H1" for standard HPL and the last "???" with "SV" for silver. "BK" for black and "WT" for white finish.

loop leg credenza - box/lateral with open storage



Right Model Shown

Model Number	Width	Depth	Height	T1	T2	
Left Model	Right Model					
RB-BLBC-2464-L-??-??	RB-BLBC-2464-R-??-??	64	24	26-7/8	\$6,466	\$6,665
RB-BLBC-2472-L-??-??	RB-BLBC-2472-R-??-??	72	24	26-7/8	\$6,739	\$6,966

- Height listed includes legs. Storage credenzas over 36" wide have a recessed middle leg.
 - Adjustable internal bars allow for two rows front-to-back, letter or legal size hanging files.
 - Includes levelers and lock.
 - To order, replace the first "???" with "T1" for standard TFL, "T2" for premium TFL, or "H1" for standard HPL and the last "???" with "SV" for silver. "BK" for black and "WT" for white finish.

low credenza - box/lateral with door storage

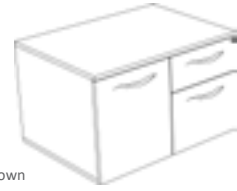

Right Model Shown

Model Number	Width	Depth	Height	T1	T2	
Left Model	Right Model					
RB-BLDL-2432-L-??	RB-BLDL-2432-R-??	32	24	19-5/8	\$1,832	\$2,016
RB-BLDL-2436-L-??	RB-BLDL-2436-R-??	36	24	19-5/8	\$1,851	\$2,036

- Includes levelers and lock on box/lateral. For lock on doors, add OP-LOCK-ADD for \$127.
 - To order, replace the first "??" with "T1" for standard TFL, "T2" for premium TFL, or "H1" for standard HPL.

low credenza - box/lateral with door storage



Right Model Shown

Model Number	Width	Depth	Height	T1	T2	
Left Model	Right Model					
RB-BLDL-2448-L-??	RB-BLDL-2448-R-??	48	24	19-5/8	\$1,874	\$2,061
RB-BLDL-2454-L-??	RB-BLDL-2454-R-??	54	24	19-5/8	\$2,130	\$2,343

- Lateral file drawer allows for two rows front to back legal or letter filing, or one row of side to side legal filing.
 - Includes levelers and lock on box/lateral. For lock on doors, add OP-LOCK-ADD for \$127.
 - To order, replace the first "??" with "T1" for standard TFL, "T2" for premium TFL, or "H1" for standard HPL.

low credenza - box/lateral with door storage



Right Model Shown

Model Number	Width	Depth	Height	T1	T2	
Left Model	Right Model					
RB-BLDL-2464-L-??	RB-BLDL-2464-R-??	64	24	19-5/8	\$2,283	\$2,511
RB-BLDL-2472-L-??	RB-BLDL-2472-R-??	72	24	19-5/8	\$2,595	\$2,854

- Lateral file drawer allows for two rows front to back legal or letter filing, or one row of side to side legal filing.
 - Includes levelers and lock on box/lateral. For lock on doors, add OP-LOCK-ADD for \$127.
 - To order, replace the first "??" with "T1" for standard TFL, "T2" for premium TFL, or "H1" for standard HPL.

loop leg credenza - box/lateral with door storage

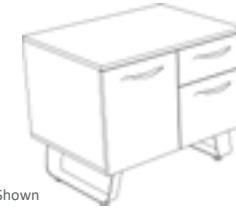

Right Model Shown

Model Number	Width	Depth	Height	T1	T2	
Left Model	Right Model					
RB-BLDC-2432-L-??-??	RB-BLDC-2432-R-??-??	32	24	26-7/8	\$4,900	\$5,084
RB-BLDC-2436-L-??-??	RB-BLDC-2436-R-??-??	36	24	26-7/8	\$4,919	\$5,104

- Height listed includes legs.
 - Includes levelers and lock.
 - To order, replace the first "??" with "T1" for standard TFL, "T2" for premium TFL, or "H1" for standard HPL and the last "??" with "SV" for silver. "BK" for black and "WT" for white finish.

loop leg credenza - box/lateral with door storage

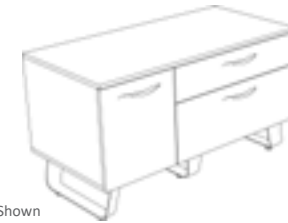

Right Model Shown

Model Number	Width	Depth	Height	T1	T2	
Left Model	Right Model					
RB-BLDC-2448-L-??-??	RB-BLDC-2448-R-??-??	48	24	26-7/8	\$6,344	\$6,531
RB-BLDC-2454-L-??-??	RB-BLDC-2454-R-??-??	54	24	26-7/8	\$6,600	\$6,813

- Height listed includes legs. Storage credenzas over 36" wide have a recessed middle leg.
 - Adjustable internal bars allow for two rows front-to-back, letter or legal size hanging files.
 - Includes levelers and lock.
 - To order, replace the first "??" with "T1" for standard TFL, "T2" for premium TFL, or "H1" for standard HPL and the last "??" with "SV" for silver. "BK" for black and "WT" for white finish.

loop leg credenza - box/lateral with door storage



Right Model Shown

Model Number	Width	Depth	Height	T1	T2	
Left Model	Right Model					
RB-BLDC-2464-L-??-??	RB-BLDC-2464-R-??-??	64	24	26-7/8	\$6,753	\$6,981
RB-BLDC-2472-L-??-??	RB-BLDC-2472-R-??-??	72	24	26-7/8	\$7,065	\$7,324

- Height listed includes legs. Storage credenzas over 36" wide have a recessed middle leg.
 - Adjustable internal bars allow for two rows front-to-back, letter or legal size hanging files.
 - Includes levelers and lock.
 - To order, replace the first "??" with "T1" for standard TFL, "T2" for premium TFL, or "H1" for standard HPL and the last "??" with "SV" for silver. "BK" for black and "WT" for white finish.

low credenza - door storage with open storage



Left Model Shown

Model Number	Width	Depth	Height	T1	T2
Left Model	Right Model				
RB-DBKL-2432-L-??	32	24	19-5/8	\$1,333	\$1,467
RB-DBKL-2436-L-??	36	24	19-5/8	\$1,515	\$1,667

- For lock, add OP-LOCK-ADD for \$127.
 - Includes levelers.
 - To order, replace the first "??" with "T1" for standard TFL, "T2" for premium TFL, or "H1" for standard HPL.

low credenza - door storage with open storage



Left Model Shown

Model Number	Width	Depth	Height	T1	T2
Left Model	Right Model				
RB-DBKL-2448-L-??	48	24	19-5/8	\$1,705	\$1,875
RB-DBKL-2454-L-??	54	24	19-5/8	\$1,936	\$2,130

- For lock, add OP-LOCK-ADD for \$127.
 - Includes levelers.
 - To order, replace the first "??" with "T1" for standard TFL, "T2" for premium TFL, or "H1" for standard HPL.

low credenza - door storage with open storage



Left Model Shown

Model Number	Width	Depth	Height	T1	T2
Left Model	Right Model				
RB-DBKL-2464-L-??	64	24	19-5/8	\$1,952	\$2,147
RB-DBKL-2472-L-??	72	24	19-5/8	\$2,220	\$2,442

- For lock, add OP-LOCK-ADD for \$127.
 - Includes levelers.
 - To order, replace the first "??" with "T1" for standard TFL, "T2" for premium TFL, or "H1" for standard HPL.

loop leg credenza - door storage with open storage

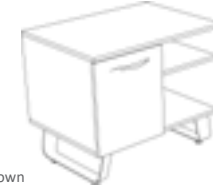

Left Model Shown

Model Number	Width	Depth	Height	T1	T2
Left Model	Right Model				
RB-DBKC-2432-L-??-??	32	24	26-7/8	\$4,401	\$4,535
RB-DBKC-2436-L-??-??	36	24	26-7/8	\$4,583	\$4,735

- For lock, add OP-LOCK-ADD for \$127.
 - Height listed includes legs.
 - Includes levelers.
 - To order, replace the first "??" with "T1" for standard TFL, "T2" for premium TFL, or "H1" for standard HPL and the last "??" with "SV" for silver. "BK" for black and "WT" for white finish.

loop leg credenza - door storage with open storage



Left Model Shown

Model Number	Width	Depth	Height	T1	T2
Left Model	Right Model				
RB-DBKC-2448-L-??-??	48	24	26-7/8	\$6,175	\$6,345
RB-DBKC-2454-L-??-??	54	24	26-7/8	\$6,406	\$6,600

- For lock, add OP-LOCK-ADD for \$127.
 - Height listed includes legs. Storage credenzas over 36" wide have a recessed middle leg.
 - Includes levelers.
 - To order, replace the first "??" with "T1" for standard TFL, "T2" for premium TFL, or "H1" for standard HPL and the last "??" with "SV" for silver. "BK" for black and "WT" for white finish.

loop leg credenza - door storage with open storage



Left Model Shown

Model Number	Width	Depth	Height	T1	T2
Left Model	Right Model				
RB-DBKC-2464-L-??-??	64	24	26-7/8	\$6,422	\$6,617
RB-DBKC-2472-L-??-??	72	24	26-7/8	\$6,690	\$6,912

- For lock, add OP-LOCK-ADD for \$127.
 - Height listed includes legs. Storage credenzas over 36" wide have a recessed middle leg.
 - Includes levelers.
 - To order, replace the first "??" with "T1" for standard TFL, "T2" for premium TFL, or "H1" for standard HPL and the last "??" with "SV" for silver. "BK" for black and "WT" for white finish.

low credenza - door storage



Model Number	Width	Depth	Height	T1	T2
RB-DRCL-2436-??	32	24	19-5/8	\$1,216	\$1,338
RB-DRCL-2436-??	36	24	19-5/8	\$1,381	\$1,519

- For lock, add OP-LOCK-ADD for \$127.
 - Includes levelers.
 - To order, replace the first "???" with "T1" for standard TFL, "T2" for premium TFL, or "H1" for standard HPL.

low credenza - door storage



Right Model Shown

Model Number	Width	Depth	Height	T1	T2	
Left Model	Right Model					
RB-DRCL-2448-L-??	RB-DRCL-2448-R-??	48	24	19-5/8	\$1,831	\$2,014
RB-DRCL-2454-L-??	RB-DRCL-2454-R-??	54	24	19-5/8	\$2,082	\$2,290

- For lock, add OP-LOCK-ADD for \$127.
 - Includes levelers.
 - To order, replace the first "???" with "T1" for standard TFL, "T2" for premium TFL, or "H1" for standard HPL.

low credenza - door storage



Model Number	Width	Depth	Height	T1	T2
RB-DRCL-2464-??	64	24	19-5/8	\$2,239	\$2,463
RB-DRCL-2472-??	72	24	19-5/8	\$2,547	\$2,802

- For lock, add OP-LOCK-ADD for \$127.
 - Includes levelers.
 - To order, replace the first "???" with "T1" for standard TFL, "T2" for premium TFL, or "H1" for standard HPL.

loop leg credenza - door storage

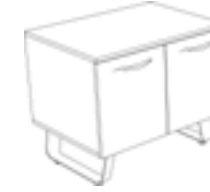

Model Number	Width	Depth	Height	T1	T2
RB-DRCC-2432??-??	32	24	26-7/8	\$4,284	\$4,406
RB-DRCC-2436??-??	36	24	26-7/8	\$4,449	\$4,587

- For lock, add OP-LOCK-ADD for \$127.
 - Height listed includes legs.
 - Includes levelers.
 - To order, replace the first "???" with "T1" for standard TFL, "T2" for premium TFL, or "H1" for standard HPL and the last "???" with "SV" for silver. "BK" for black and "WT" for white finish.

loop leg credenza - door storage

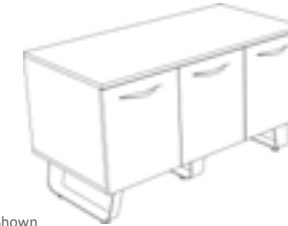

Right Model Shown

Model Number	Width	Depth	Height	T1	T2	
Left Model	Right Model					
RB-DRCC-2448-L-??-??	RB-DRCC-2448-R-??-??	48	24	26-7/8	\$6,301	\$6,484
RB-DRCC-2454-L-??-??	RB-DRCC-2454-R-??-??	54	24	26-7/8	\$6,552	\$6,760

- For lock, add OP-LOCK-ADD for \$127.
 - Height listed includes legs. Storage credenzas over 36" wide have a recessed middle leg.
 - Includes levelers.
 - To order, replace the first "???" with "T1" for standard TFL, "T2" for premium TFL, or "H1" for standard HPL and the last "???" with "SV" for silver. "BK" for black and "WT" for white finish.

loop leg credenza - door storage



Model Number	Width	Depth	Height	T1	T2
RB-DRCC-2464-??-??	64	24	26-7/8	\$6,709	\$6,933
RB-DRCC-2472-??-??	72	24	26-7/8	\$7,017	\$7,272

- For lock, add OP-LOCK-ADD for \$127.
 - Height listed includes legs. Storage credenzas over 36" wide have a recessed middle leg.
 - Includes levelers.
 - To order, replace the first "???" with "T1" for standard TFL, "T2" for premium TFL, or "H1" for standard HPL and the last "???" with "SV" for silver. "BK" for black and "WT" for white finish.

low credenza - open storage



Model Number	Width	Depth	Height	T1	T2
RB-BKCL-2432-??	32	24	19-5/8	\$1,041	\$1,145
RB-BKCL-2436-??	36	24	19-5/8	\$1,183	\$1,301

- Includes levelers.
 - To order, replace the first "???" with "T1" for standard TFL, "T2" for premium TFL, or "H1" for standard HPL.

low credenza - open storage



Left Model Shown

Model Number	Width	Depth	Height	T1	T2	
Left Model RB-BKCL-2448-L-??	Right Model RB-BKCL-2448-R-??	48	24	19-5/8	\$1,559	\$1,715
Left Model RB-BKCL-2454-L-??	Right Model RB-BKCL-2454-R-??	54	24	19-5/8	\$1,611	\$1,772

- Includes levelers.
 - To order, replace the first "???" with "T1" for standard TFL, "T2" for premium TFL, or "H1" for standard HPL.

low credenza - open storage



Model Number	Width	Depth	Height	T1	T2
RB-BKCL-2464-??	64	24	19-5/8	\$1,834	\$2,017
RB-BKCL-2472-??	72	24	19-5/8	\$2,086	\$2,295

- Includes levelers.
 - To order, replace the first "???" with "T1" for standard TFL, "T2" for premium TFL, or "H1" for standard HPL.

loop leg credenza - open storage



Model Number	Width	Depth	Height	T1	T2
RB-BKCC-2432-??-??	32	24	26-7/8	\$4,109	\$8,733
RB-BKCC-2436-??-??	36	24	26-7/8	\$4,251	\$4,369

- Height listed includes legs.
 - Includes levelers.
 - To order, replace the first "???" with "T1" for standard TFL, "T2" for premium TFL, or "H1" for standard HPL and the last "???" with "SV" for silver. "BK" for black and "WT" for white finish.

loop leg credenza - open storage



Left Model Shown

Model Number	Width	Depth	Height	T1	T2	
Left Model RB-BKCC-2448-L-??-??	Right Model RB-BKCC-2448-R-??-??	48	24	26-7/8	\$6,029	\$6,185
Left Model RB-BKCC-2454-L-??-??	Right Model RB-BKCC-2454-R-??-??	54	24	26-7/8	\$6,081	\$6,242

- Height listed includes legs. Storage credenzas over 36" wide have a recessed middle leg.
 - Includes levelers.
 - To order, replace the first "???" with "T1" for standard TFL, "T2" for premium TFL, or "H1" for standard HPL and the last "???" with "SV" for silver. "BK" for black and "WT" for white finish.

loop leg credenza - open storage



Model Number	Width	Depth	Height	T1	T2
RB-BKCC-2464-??-??	64	24	26-7/8	\$6,304	\$6,487
RB-BKCC-2472-??-??	72	24	26-7/8	\$6,556	\$6,765

- Height listed includes legs. Storage credenzas over 36" wide have a recessed middle leg.
 - Includes levelers.
 - To order, replace the first "???" with "T1" for standard TFL, "T2" for premium TFL, or "H1" for standard HPL and the last "???" with "SV" for silver. "BK" for black and "WT" for white finish.

low credenza - box/lateral



Model Number	Width	Depth	Height	T1	T2
RB-BLFL-2432-??	32	24	19-5/8	\$1,331	\$1,464
RB-BLFL-2436-??	36	24	19-5/8	\$1,514	\$1,665

- Lateral file drawer allows for two rows front to back legal or letter filing, or one row of side to side legal filing.
- Includes levelers and lock.
- To order, replace the first "??" with "T1" for standard TFL, "T2" for premium TFL, or "H1" for standard HPL.

low credenza - double box/lateral



Model Number	Width	Depth	Height	T1	T2
RB-BLFL-2464-??	64	24	19-5/8	\$2,295	\$2,524
RB-BLFL-2472-??	72	24	19-5/8	\$2,642	\$2,907

- Lateral file drawer allows for two rows front to back legal or letter filing, or one row of side to side legal filing.
- Includes levelers and lock.
- To order, replace the first "??" with "T1" for standard TFL, "T2" for premium TFL, or "H1" for standard HPL.

loop leg credenza - box/lateral



Model Number	Width	Depth	Height	T1	T2
RB-BLFC-2432-??-??	32	24	26-7/8	\$4,399	\$4,532
RB-BLFC-2436-??-??	36	24	26-7/8	\$4,582	\$4,733

- Height listed includes legs.
- Adjustable internal bars allow for two rows front-to-back, letter or legal size hanging files.
- Includes levelers and lock.
- To order, replace the first "??" with "T1" for standard TFL, "T2" for premium TFL, or "H1" for standard HPL and the last "??" with "SV" for silver. "BK" for black and "WT" for white finish.

loop leg credenza - double box/lateral



Model Number	Width	Depth	Height	T1	T2
RB-BLFC-2464-??-??	64	24	26-7/8	\$6,765	\$6,994
RB-BLFC-2472-??-??	72	24	26-7/8	\$7,112	\$7,377

- Height listed includes legs. Storage credenzas over 36" wide have a recessed middle leg.
- Adjustable internal bars allow for two rows front-to-back, letter or legal size hanging files.
- Includes levelers and lock.
- To order, replace the first "??" with "T1" for standard TFL, "T2" for premium TFL, or "H1" for standard HPL and the last "??" with "SV" for silver. "BK" for black and "WT" for white finish.

support pedestal - box/box/file



Model Number	Width	Depth	Height	T1	T2
RB-PDBF-2416-??	16	24	28	\$1,350	\$1,485

- Support pedestals have 1-1/8" thick kickplate on bottom.
- Adjustable internal bars allow for two rows front-to-back, letter or legal size hanging files.
- Includes levelers and lock.
- To order, replace the first "???" with "T1" for standard TFL, "T2" for premium TFL, or "H1" for standard HPL.

support pedestal - file/file



Model Number	Width	Depth	Height	T1	T2
RB-PDFF-2416-??	16	24	28	\$1,350	\$1,485

- Support pedestals have 1-1/8" thick kickplate on bottom.
- Adjustable internal bars allow for two rows front-to-back, letter or legal size hanging files.
- Includes levelers and lock.
- To order, replace the first "???" with "T1" for standard TFL, "T2" for premium TFL, or "H1" for standard HPL.

support pedestal - open storage



Model Number	Width	Depth	Height	T1	T2
RB-PDBS-2416-??	16	24	28	\$817	\$898

- Support pedestals have 1-1/8" thick kickplate on bottom.
- Includes levelers.
- To order, replace the first "???" with "T1" for standard TFL, "T2" for premium TFL, or "H1" for standard HPL.

support pedestal - door storage



Model Number	Width	Depth	Height	T1	T2
Left Model RB-PDSC-2416-L-??	16	24	28	\$1,220	\$1,342
Right Model RB-PDSC-2416-R-??					

- Support pedestals have 1-1/8" thick kickplate on bottom.
- For lock on door, add OP-LOCK-ADD for \$127.
- To order, replace the first "???" with "T1" for standard TFL, "T2" for premium TFL, or "H1" for standard HPL.

support pedestal - lateral file



Model Number	Width	Depth	Height	T1	T2
RB-PDLF-2432-??	32	24	28	\$1,604	\$1,764
RB-PDLF-2436-??	36	24	28	\$1,649	\$1,814

- Support pedestals have 1-1/8" thick kickplate on bottom.
- Lateral file drawer allows for two rows front to back legal or letter filing, or one row of side to side legal filing.
- Includes levelers and lock.
- To order, replace the first "???" with "T1" for standard TFL, "T2" for premium TFL, or "H1" for standard HPL.

support pedestal - open storage



Model Number	Width	Depth	Height	T1	T2
RB-PDBS-2432-??	32	24	28	\$1,000	\$1,100
RB-PDBS-2436-??	36	24	28	\$1,046	\$1,151

- Support pedestals have 1-1/8" thick kickplate on bottom.
- Includes levelers.
- To order, replace the first "???" with "T1" for standard TFL, "T2" for premium TFL, or "H1" for standard HPL.

support pedestal - door storage



Model Number	Width	Depth	Height	T1	T2
RB-PDSC-2432-??	32	24	28	\$1,474	\$1,621
RB-PDSC-2436-??	36	24	28	\$1,520	\$1,672

- Support pedestals have 1-1/8" thick kickplate on bottom.
- For lock on doors, add OP-LOCK-ADD for \$127.
- To order, replace the first "???" with "T1" for standard TFL, "T2" for premium TFL, or "H1" for standard HPL.

support pedestal - file center



Model Number	Width	Depth	Height	T1	T2
RB-PDFC-2432-??	32	24	28	\$1,733	\$1,906

- Support pedestals have 1-1/8" thick kickplate on bottom.
- Lateral file drawer allows for two rows front to back legal or letter filing, or one row of side to side legal filing.
- Includes levelers and lock.
- To order, replace the first "???" with "T1" for standard TFL, "T2" for premium TFL, or "H1" for standard HPL.

storage tower - single door wardrobe



Model Number	Width	Depth	Height	T1	T2	
Left Model	Right Model					
RB-SDW4-2454-L-??-??	RB-SDW4-2454-R-??-??	20	24	54	\$4,414	\$4,548
RB-SDW4-2460-L-??-??	RB-SDW4-2460-R-??-??	20	24	60	\$4,551	\$4,700
RB-SDW4-2466-L-??-??	RB-SDW4-2466-R-??-??	20	24	66	\$4,584	\$4,736
RB-SDW4-2472-L-??-??	RB-SDW4-2472-R-??-??	20	24	72	\$4,657	\$4,816

- Height listed includes legs.
- Includes single shelf and closet rod.
- For lock on doors, add OP-LOCK-ADD for \$127.
- To order, replace the first "???" with "T1" for standard TFL, "T2" for premium TFL, or "H1" for standard HPL and the last "??" with "SV" for silver. "BK" for black and "WT" for white finish.

storage tower - double door wardrobe



Model Number	Width	Depth	Height	T1	T2
RB-WDR3-2454-??-??	30	24	54	\$4,673	\$4,834
RB-WDR3-2460-??-??	30	24	60	\$4,808	\$4,983
RB-WDR3-2466-??-??	30	24	66	\$4,844	\$5,022
RB-WDR3-2472-??-??	30	24	72	\$4,916	\$5,101
RB-WDRB-2454-??-??	36	24	54	\$4,728	\$4,894
RB-WDRB-2460-??-??	36	24	60	\$4,868	\$5,048
RB-WDRB-2466-??-??	36	24	66	\$4,902	\$5,086
RB-WDRB-2472-??-??	36	24	72	\$4,971	\$5,161

- Height listed includes legs.
- Includes single shelf and closet rod.
- For lock on doors, add OP-LOCK-ADD for \$127.
- To order, replace the first "???" with "T1" for standard TFL, "T2" for premium TFL, or "H1" for standard HPL and the last "??" with "SV" for silver. "BK" for black and "WT" for white finish.

storage tower - split storage with adjustable shelves



Model Number	Width	Depth	Height	T1	T2	
Left Model RB-SCFW-2454-L-??-??	Right Model RB-SCFW-2454-R-??-??	20	24	54	\$4,532	\$4,679
RB-SCFW-2460-L-??-??	RB-SCFW-2460-R-??-??	20	24	60	\$4,671	\$4,831
RB-SCFW-2466-L-??-??	RB-SCFW-2466-R-??-??	20	24	66	\$4,704	\$4,868
RB-SCFW-2472-L-??-??	RB-SCFW-2472-R-??-??	20	24	72	\$4,775	\$4,946

- Height listed includes legs.
 - For lock on doors, add OP-LOCK-ADD for \$127. Each door requires a lock.
 - To order, replace the first "??" with "T1" for standard TFL, "T2" for premium TFL, or "H1" for standard HPL and the last "??" with "SV" for silver. "BK" for black and "WT" for white finish.

storage tower - split storage with adjustable shelves



Model Number	Width	Depth	Height	T1	T2
RB-SCFW-3054-??-??	30	24	54	\$4,846	\$5,024
RB-SCFW-3060-??-??	30	24	60	\$4,982	\$5,173
RB-SCFW-3066-??-??	30	24	66	\$5,016	\$5,211
RB-SCFW-3072-??-??	30	24	72	\$5,085	\$5,286
RB-SCFW-3654-??-??	36	24	54	\$4,901	\$5,084
RB-SCFW-3660-??-??	36	24	60	\$5,040	\$5,237
RB-SCFW-3666-??-??	36	24	66	\$5,075	\$5,276
RB-SCFW-3672-??-??	36	24	72	\$5,144	\$5,352

- Height listed includes legs.
 - For lock on doors, add OP-LOCK-ADD for \$127. Each set of doors requires a lock.
 - To order, replace the first "??" with "T1" for standard TFL, "T2" for premium TFL, or "H1" for standard HPL and the last "??" with "SV" for silver. "BK" for black and "WT" for white finish.

storage tower - single door with adjustable shelves



Model Number	Width	Depth	Height	T1	T2	
Left Model RB-SCF6-2454-L-??-??	Right Model RB-SCF6-2454-R-??-??	20	24	54	\$4,414	\$4,548
RB-SCF6-2460-L-??-??	RB-SCF6-2460-R-??-??	20	24	60	\$4,551	\$4,700
RB-SCF6-2466-L-??-??	RB-SCF6-2466-R-??-??	20	24	66	\$4,584	\$4,736
RB-SCF6-2472-L-??-??	RB-SCF6-2472-R-??-??	20	24	72	\$4,657	\$4,816

- Height listed includes legs.
 - For lock on doors, add OP-LOCK-ADD for \$127.
 - To order, replace the first "??" with "T1" for standard TFL, "T2" for premium TFL, or "H1" for standard HPL and the last "??" with "SV" for silver. "BK" for black and "WT" for white finish.

storage tower - double door with adjustable shelves



Model Number	Width	Depth	Height	T1	T2
RB-SCF1-2454-??-??	30	24	54	\$4,673	\$4,834
RB-SCF1-2460-??-??	30	24	60	\$4,808	\$4,983
RB-SCF1-2466-??-??	30	24	66	\$4,844	\$5,022
RB-SCF1-2472-??-??	30	24	72	\$4,916	\$5,101
RB-SCF2-2454-??-??	36	24	54	\$4,728	\$4,894
RB-SCF2-2460-??-??	36	24	60	\$4,868	\$5,048
RB-SCF2-2466-??-??	36	24	66	\$4,902	\$5,086
RB-SCF2-2472-??-??	36	24	72	\$4,971	\$5,161

- Height listed includes legs.
 - For lock on doors, add OP-LOCK-ADD for \$127.
 - To order, replace the first "??" with "T1" for standard TFL, "T2" for premium TFL, or "H1" for standard HPL and the last "??" with "SV" for silver. "BK" for black and "WT" for white finish.

wall mounted open storage

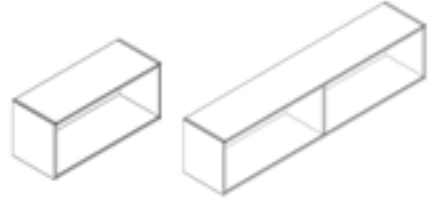

Model Number	Width	Depth	Height	T1	T2
No Center Partition					
RB-WMOO-3016-??	30	14	16	\$747	\$822
RB-WMOO-3616-??	36	14	16	\$800	\$880
RB-WMOO-4216-??	42	14	16	\$978	\$1,076
Center Partition					
RB-WMOO-4816-??	48	14	16	\$1,021	\$1,123
RB-WMOO-5416-??	54	14	16	\$1,259	\$1,385
RB-WMOO-6016-??	60	14	16	\$1,495	\$1,645
RB-WMOO-6616-??	66	14	16	\$1,548	\$1,703
RB-WMOO-7216-??	72	14	16	\$1,602	\$1,762
RB-WMOO-7816-??	78	14	16	\$1,779	\$1,957
RB-WMOO-8416-??	84	14	16	\$1,957	\$2,153

- All units include hardware for mounting. Must be professionally installed.
 - Weight capacity of 50 lbs. per piece.
 - To order, replace the first "??" with "T1" for standard TFL, "T2" for premium TFL, or "H1" for standard HPL.

wall mounted sliding door storage

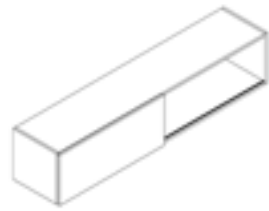

Model Number	Width	Depth	Height	T1	T2
RB-WMOL-4816-??	48	15	16	\$1,927	\$2,119
RB-WMOL-5416-??	54	15	16	\$2,198	\$2,418
RB-WMOL-6016-??	60	15	16	\$2,273	\$2,500
RB-WMOL-6616-??	66	15	16	\$2,347	\$2,582
RB-WMOL-7216-??	72	15	16	\$2,421	\$2,663
RB-WMOL-7816-??	78	15	16	\$2,559	\$2,814
RB-WMOL-8416-??	84	15	16	\$2,682	\$2,950

- All units include hardware for mounting. Must be professionally installed.
 - Weight capacity of 50 lbs. per piece.
 - To order, replace the first "??" with "T1" for standard TFL, "T2" for premium TFL, or "H1" for standard HPL.

wall mounted hinged door storage

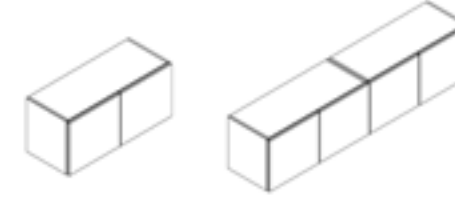

Model Number	Width	Depth	Height	T1	T2
Two Door					
RB-HCHT-3016-??	30	15	16	\$979	\$1,077
RB-HCHT-3616-??	36	15	16	\$1,065	\$1,171
RB-HCHT-4216-??	42	15	16	\$1,158	\$1,274
RB-HCHT-4816-??	48	15	16	\$1,465	\$1,612
Four Door					
RB-HCHT-5416-??	54	15	16	\$1,737	\$1,911
RB-HCHT-6016-??	60	15	16	\$1,813	\$1,994
RB-HCHT-6616-??	66	15	16	\$1,887	\$2,076
RB-HCHT-7216-??	72	15	16	\$1,961	\$2,157
RB-HCHT-7816-??	78	15	16	\$2,099	\$2,308
RB-HCHT-8416-??	84	15	16	\$2,222	\$2,444

- All units include hardware for mounting. Must be professionally installed.
 - Weight capacity of 50 lbs. per piece.
 - To order, replace the first "??" with "T1" for standard TFL, "T2" for premium TFL, or "H1" for standard HPL.

conference tables



details

- Metal open frame support legs are sold as sets with spanning rods.
- Legs are constructed of 1/2" thick x 2-1/2" deep steel frame with a powdercoat finish.
- Spanning rods are approximately 1" square steel with a silver powdercoat finish.
- Includes leveling glides. Levelers will add 3/4" in height.
- Support legs are 19" wide, 24" wide, 30" wide & 36" wide.
- Ribbon conference table bases can be completed with rectangular or boatshaped tops.
- Minimum table size: 36" x 72"; maximum table size: 60" x 240".
- Made in America.

finishes

standard

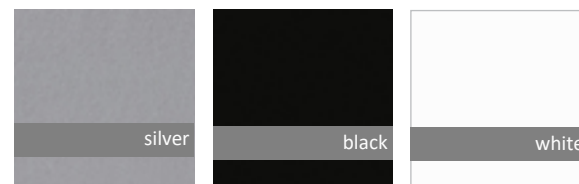

dimensions

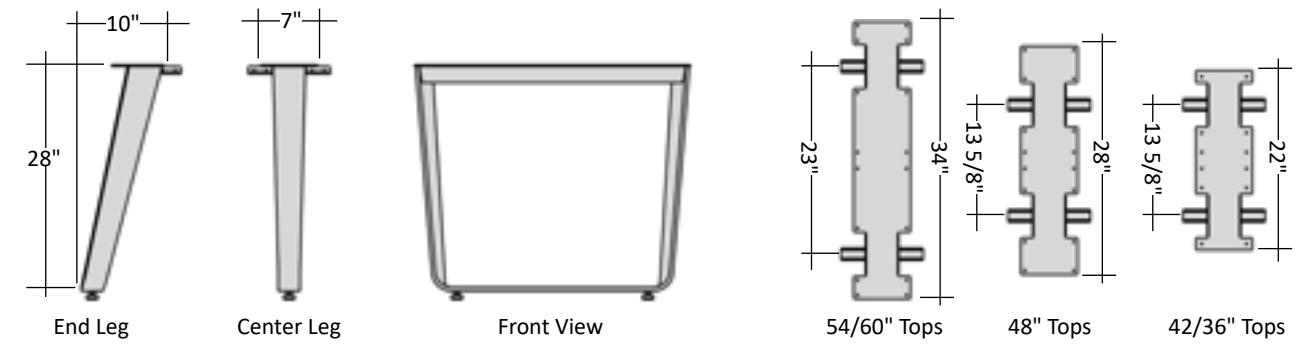
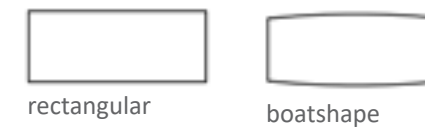

table tops for ribbon bases



base placement

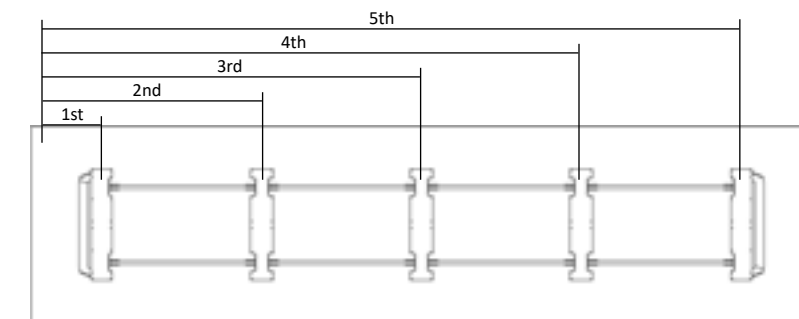

Table Depth	Table Length	Center of 1st Base	Center of 2nd Base	Center of 3rd Base	Center of 4th Base	Center of 5th Base
36	72	22 1/4	49 3/4			
42/48	84	22 1/4	61 3/4			
42/48	96	22 1/4	73 3/4			
48	120	21 3/4	60	98 1/4		
48/54/60	144	21 3/4	72	122 1/4		
48/54/60	168	22 1/4	63 1/2	104 1/2	145 3/4	
48/54/60	192	22 1/4	71 1/2	120 1/2	169 3/4	
48/54/60	216	21 3/4	65	108	151	194 1/4
48/54/60	240	21 3/4	71	120	169	218 1/4

ribbon hairpin leg



details

- Heavy gauge steel construction.
- Includes leveling glides. Levelers will add 3/4" in height.
- Powdercoat finish.
- Made in America.

finishes

standard

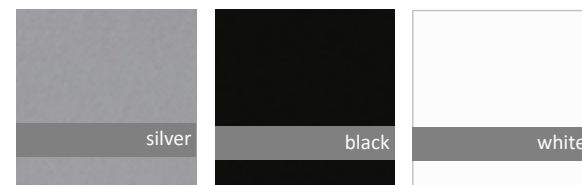

dimensions

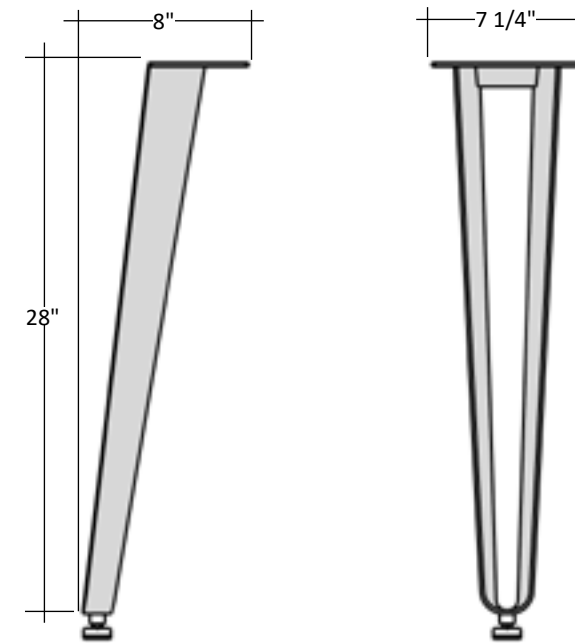

placement

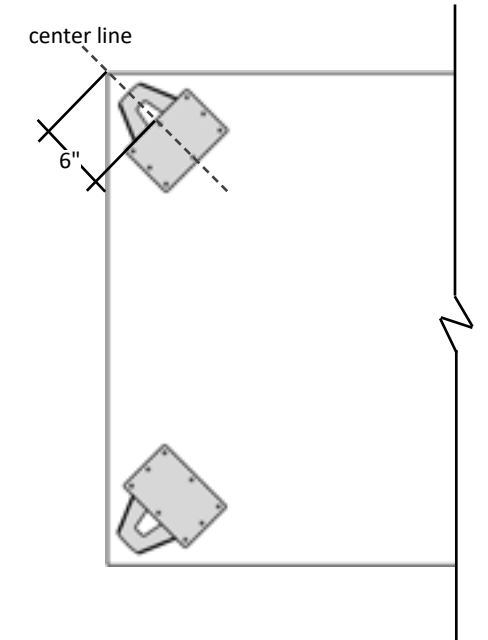
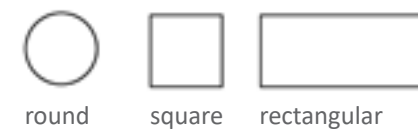

table tops for hairpin legs

one piece table tops only, maximum width 48"



round square rectangular

orientation

for mounting ribbon legs

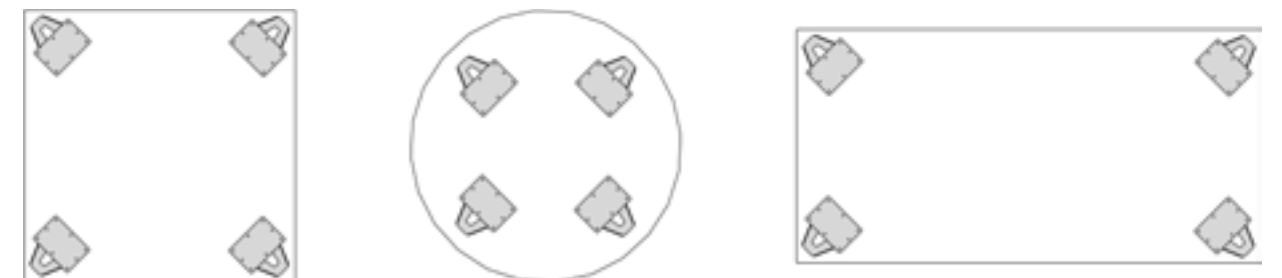

rectangular table top

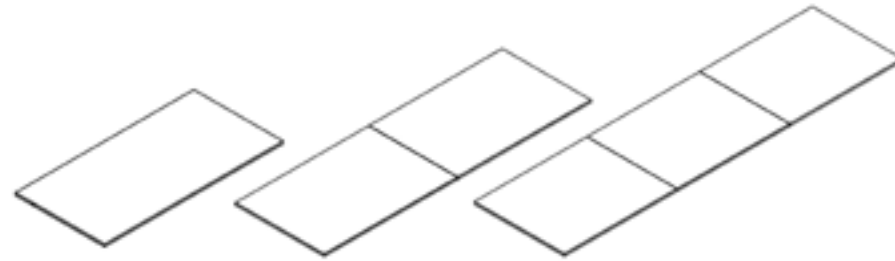

Model Number	Depth	Length	TFL		HPL
			1-1/8" Thick Standard TFL 2mm PVC	1-1/8" Thick Premium TFL 2mm PVC	1-1/8" Thick Standard HPL 2mm PVC
			T1-A1	T2-A1	H1-A1
One Piece Tops					
RB-REC1-3672-??-??	36	72	\$807	\$888	\$1,406
RB-REC1-4284-??-??	42	84	\$834	\$917	\$1,417
RB-REC1-4884-??-??	48	84	\$846	\$931	\$1,444
RB-REC1-4296-??-??	42	96	\$926	\$1,018	\$1,463
RB-REC1-4896-??-??	48	96	\$1,023	\$1,125	\$1,615
RB-REC1-4820-??-??	48	120	N/A	N/A	\$2,220
Two Piece Tops					
RB-REC2-4820-??-??	48	120	\$1,759	\$1,935	\$2,964
RB-REC2-4844-??-??	48	144	\$2,052	\$2,257	\$3,241
RB-REC2-4868-??-??	48	168	\$2,458	\$2,704	\$3,881
RB-REC2-4892-??-??	48	192	\$2,880	\$3,168	\$4,548
RB-REC2-4816-??-??	48	216	N/A	N/A	\$5,465
RB-REC2-4840-??-??	48	240	N/A	N/A	\$6,266
RB-REC2-5444-??-??	54	144	\$2,298	\$2,527	\$3,628
RB-REC2-5468-??-??	54	168	\$2,690	\$2,959	\$4,247
RB-REC2-5492-??-??	54	192	\$3,149	\$3,464	\$4,971
RB-REC2-5416-??-??	54	216	N/A	N/A	\$5,961
RB-REC2-5440-??-??	54	240	N/A	N/A	\$6,860
RB-REC2-6044-??-??	60	144	\$2,530	\$2,783	\$3,994
RB-REC2-6068-??-??	60	168	\$2,959	\$3,255	\$4,672
RB-REC2-6092-??-??	60	192	\$3,462	\$3,808	\$5,469
RB-REC2-6016-??-??	60	216	N/A	N/A	\$6,558
RB-REC2-6040-??-??	60	240	N/A	N/A	\$7,545
Three Piece Tops					
RB-REC3-4816-??-??	48	216	\$3,575	\$3,932	\$5,645
RB-REC3-4840-??-??	48	240	\$4,087	\$4,496	\$6,453
RB-REC3-5416-??-??	54	216	\$3,952	\$4,347	\$6,240
RB-REC3-5440-??-??	54	240	\$4,521	\$4,973	\$7,139
RB-REC3-6016-??-??	60	216	\$4,330	\$4,763	\$6,836
RB-REC3-6040-??-??	60	240	\$4,956	\$5,452	\$7,824

- TFL and HPL tops with 2mm PVC edges are only available with DeskMakers standard 2MM PVC edgebanding.
 - 120" one piece conference table tops not available in all TFL finishes.
 - For two piece and three piece table tops, please note that the grain pattern will not line up at the seams.
 - Tables with sections larger than 96" are available in Southern California and/or will call only.

rounded corner rectangular table top

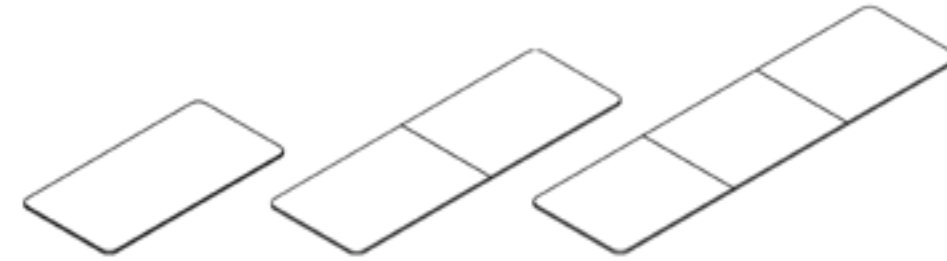

Model Number	Depth	Length	TFL		HPL
			1-1/8" Thick Standard TFL 2mm PVC	1-1/8" Thick Premium TFL 2mm PVC	1-1/8" Thick Standard HPL 2mm PVC
			T1-A1	T2-A1	H1-A1
One Piece Tops					
RB-RCR1-3672-??-??	36	72	\$957	\$1,053	\$1,638
RB-RCR1-4284-??-??	42	84	\$984	\$1,082	\$1,650
RB-RCR1-4884-??-??	48	84	\$996	\$1,096	\$1,678
RB-RCR1-4296-??-??	42	96	\$1,076	\$1,183	\$1,697
RB-RCR1-4896-??-??	48	96	\$1,173	\$1,290	\$1,858
RB-RCR1-4820-??-??	48	120	N/A	N/A	\$2,495
Two Piece Tops					
RB-RCR2-4820-??-??	48	120	\$1,909	\$2,100	\$3,277
RB-RCR2-4844-??-??	48	144	\$2,202	\$2,422	\$3,569
RB-RCR2-4868-??-??	48	168	\$2,608	\$2,869	\$4,243
RB-RCR2-4892-??-??	48	192	\$3,030	\$3,333	\$4,945
RB-RCR2-4816-??-??	48	216	N/A	N/A	\$5,911
RB-RCR2-4840-??-??	48	240	N/A	N/A	\$6,753
RB-RCR2-5444-??-??	54	144	\$2,448	\$2,692	\$3,977
RB-RCR2-5468-??-??	54	168	\$2,840	\$3,124	\$4,628
RB-RCR2-5492-??-??	54	192	\$3,299	\$3,629	\$5,391
RB-RCR2-5416-??-??	54	216	N/A	N/A	\$6,433
RB-RCR2-5440-??-??	54	240	N/A	N/A	\$7,379
RB-RCR2-6044-??-??	60	144	\$2,680	\$2,948	\$4,362
RB-RCR2-6068-??-??	60	168	\$3,109	\$3,420	\$5,076
RB-RCR2-6092-??-??	60	192	\$3,612	\$3,973	\$5,915
RB-RCR2-6016-??-??	60	216	N/A	N/A	\$7,061
RB-RCR2-6040-??-??	60	240	N/A	N/A	\$8,100
Three Piece Tops					
RB-RCR3-4816-??-??	48	216	\$3,725	\$4,097	\$6,100
RB-RCR3-4840-??-??	48	240	\$4,237	\$4,661	\$6,951
RB-RCR3-5416-??-??	54	216	\$4,102	\$4,512	\$6,726
RB-RCR3-5440-??-??	54	240	\$4,671	\$5,138	\$7,672
RB-RCR3-6016-??-??	60	216	\$4,480	\$4,928	\$7,354
RB-RCR3-6040-??-??	60	240	\$5,106	\$5,617	\$8,393

- TFL and HPL tops with 2mm PVC edges are only available with DeskMakers standard 2MM PVC edgebanding.
 - 120" one piece conference table tops not available in all TFL finishes.
 - For two piece and three piece table tops, please note that the grain pattern will not line up at the seams.
 - Tables with sections larger than 96" are available in Southern California and/or will call only.
 - Rounded corner will have a 4" radius.

boatshaped table top

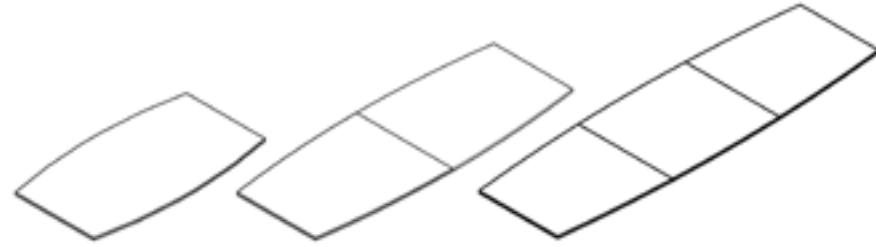

Model Number	Depth	Length	TFL		HPL
			1-1/8" Thick Standard TFL 2mm PVC	1-1/8" Thick Premium TFL 2mm PVC	1-1/8" Thick Standard HPL 2mm PVC
			T1-A1	T2-A1	H1-A1
One Piece Tops					
RB-BOT1-3672-??-??	30-36	72	\$839	\$923	\$1,430
RB-BOT1-4284-??-??	36-42	84	\$953	\$1,048	\$1,506
RB-BOT1-4884-??-??	42-48	84	\$1,047	\$1,152	\$1,653
RB-BOT1-4296-??-??	36-42	96	\$1,076	\$1,183	\$1,702
RB-BOT1-4896-??-??	42-48	96	\$1,170	\$1,288	\$1,848
RB-BOT1-4820-??-??	42-48	120	N/A	N/A	\$2,450
Two Piece Tops					
RB-BOT2-4820-??-??	42-48	120	\$1,794	\$1,973	\$3,001
RB-BOT2-4844-??-??	42-48	144	\$2,227	\$2,450	\$3,517
RB-BOT2-4868-??-??	42-48	168	\$2,631	\$2,894	\$4,154
RB-BOT2-4892-??-??	42-48	192	\$3,071	\$3,378	\$4,850
RB-BOT2-4816-??-??	42-48	216	N/A	N/A	\$5,829
RB-BOT2-4840-??-??	42-48	240	N/A	N/A	\$6,698
RB-BOT2-5444-??-??	44-54	144	\$2,498	\$2,747	\$3,944
RB-BOT2-5468-??-??	44-54	168	\$2,921	\$3,213	\$4,611
RB-BOT2-5492-??-??	44-54	192	\$3,415	\$3,757	\$5,394
RB-BOT2-5416-??-??	44-54	216	N/A	N/A	\$6,475
RB-BOT2-5440-??-??	44-54	240	N/A	N/A	\$7,444
RB-BOT2-6044-??-??	50-60	144	\$2,745	\$3,019	\$4,334
RB-BOT2-6068-??-??	50-60	168	\$3,211	\$3,532	\$5,071
RB-BOT2-6092-??-??	50-60	192	\$3,759	\$4,135	\$5,935
RB-BOT2-6016-??-??	50-60	216	N/A	N/A	\$7,119
RB-BOT2-6040-??-??	50-60	240	N/A	N/A	\$8,188
Three Piece Tops					
RB-BOT3-4816-??-??	42-48	216	\$3,866	\$4,253	\$6,106
RB-BOT3-4840-??-??	42-48	240	\$4,417	\$4,859	\$6,976
RB-BOT3-5416-??-??	44-54	216	\$4,275	\$4,703	\$6,750
RB-BOT3-5440-??-??	44-54	240	\$4,890	\$5,379	\$7,721
RB-BOT3-6016-??-??	50-60	216	\$4,685	\$5,153	\$7,397
RB-BOT3-6040-??-??	50-60	240	\$5,362	\$5,898	\$8,467

- TFL and HPL tops with 2mm PVC edges are only available with DeskMakers standard 2MM PVC edgebanding.
- 120" one piece conference table tops not available in all TFL finishes.
- For two piece and three piece table tops, please note that the grain pattern will not line up at the seams.
- Tables with sections larger than 96" are available in Southern California and/or will call only.

rounded corner boatshaped table top

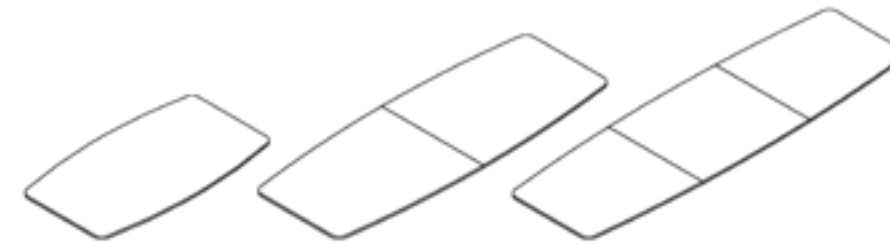

Model Number	Depth	Length	TFL		HPL
			1-1/8" Thick Standard TFL 2mm PVC	1-1/8" Thick Premium TFL 2mm PVC	1-1/8" Thick Standard HPL 2mm PVC
			T1-A1	T2-A1	H1-A1
One Piece Tops					
RB-BTR1-3672-??-??	30-36	72	\$989	\$1,088	\$1,663
RB-BTR1-4284-??-??	36-42	84	\$1,103	\$1,213	\$1,744
RB-BTR1-4884-??-??	42-48	84	\$1,197	\$1,317	\$1,898
RB-BTR1-4296-??-??	36-42	96	\$1,226	\$1,348	\$1,949
RB-BTR1-4896-??-??	42-48	96	\$1,320	\$1,453	\$2,103
RB-BTR1-4820-??-??	42-48	120	N/A	N/A	\$2,737
Two Piece Tops					
RB-BTR2-4820-??-??	42-48	120	\$1,944	\$2,138	\$3,317
RB-BTR2-4844-??-??	42-48	144	\$2,377	\$2,615	\$3,860
RB-BTR2-4868-??-??	42-48	168	\$2,781	\$3,059	\$4,531
RB-BTR2-4892-??-??	42-48	192	\$3,221	\$3,543	\$5,263
RB-BTR2-4816-??-??	42-48	216	N/A	N/A	\$6,294
RB-BTR2-4840-??-??	42-48	240	N/A	N/A	\$7,209
RB-BTR2-5444-??-??	44-54	144	\$2,648	\$2,912	\$4,309
RB-BTR2-5468-??-??	44-54	168	\$3,071	\$3,378	\$5,012
RB-BTR2-5492-??-??	44-54	192	\$3,565	\$3,922	\$5,835
RB-BTR2-5416-??-??	44-54	216	N/A	N/A	\$6,973
RB-BTR2-5440-??-??	44-54	240	N/A	N/A	\$7,993
RB-BTR2-6044-??-??	50-60	144	\$2,895	\$3,184	\$4,720
RB-BTR2-6068-??-??	50-60	168	\$3,361	\$3,697	\$5,495
RB-BTR2-6092-??-??	50-60	192	\$3,909	\$4,300	\$6,406
RB-BTR2-6016-??-??	50-60	216	N/A	N/A	\$7,651
RB-BTR2-6040-??-??	50-60	240	N/A	N/A	\$8,777
Three Piece Tops					
RB-BTR3-4816-??-??	42-48	216	\$4,016	\$4,418	\$6,586
RB-BTR3-4840-??-??	42-48	240	\$4,567	\$5,024	\$7,501
RB-BTR3-5416-??-??	44-54	216	\$4,425	\$4,868	\$7,264
RB-BTR3-5440-??-??	44-54	240	\$5,040	\$5,544	\$8,285
RB-BTR3-6016-??-??	50-60	216	\$4,835	\$5,318	\$7,944
RB-BTR3-6040-??-??	50-60	240	\$5,512	\$6,063	\$9,070

- TFL and HPL tops with 2mm PVC edges are only available with DeskMakers standard 2MM PVC edgebanding.
- 120" one piece conference table tops not available in all TFL finishes.
- For two piece and three piece table tops, please note that the grain pattern will not line up at the seams.
- Tables with sections larger than 96" are available in Southern California and/or will call only.
- Rounded corner will have a 4" radius.

round table top



Model Number	Depth	Length
CF-CTRD-4242-??-??	42	42
CF-CTRD-4848-??-??	48	48
CF-CTRD-5454-??-??	54	54
CF-CTRD-6060-??-??	60	60

TFL		HPL
1-1/8" Thick Standard TFL	1-1/8" Thick Premium TFL	1-1/8" Thick Standard HPL
2mm PVC	2mm PVC	2mm PVC
T1-A1	T2-A1	H1-A1
\$734	\$807	\$1,158
\$890	\$979	\$1,405
\$1,061	\$1,167	\$1,675
\$1,115	\$1,227	\$1,762

- TFL and HPL tops with 2mm PVC edges are only available with DeskMakers standard 2MM PVC edgebanding.

square table top

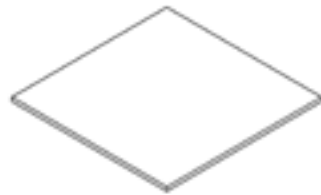

Model Number	Depth	Length
CF-CTSQ-4242-??-??	42	42
CF-CTSQ-4848-??-??	48	48
CF-CTSQ-5454-??-??	54	54

TFL		HPL
1-1/8" Thick Standard TFL	1-1/8" Thick Premium TFL	1-1/8" Thick Standard HPL
2mm PVC	2mm PVC	2mm PVC
T1-A1	T2-A1	H1-A1
\$676	\$743	\$1,068
\$833	\$917	\$1,317
\$991	\$1,090	\$1,566

- TFL and HPL tops with 2mm PVC edges are only available with DeskMakers standard 2MM PVC edgebanding.

rounded corner square table top



Model Number	Depth	Length
RB-SQRC-4242-??-??	42	42
RB-SQRC-4848-??-??	48	48
RB-SQRC-5454-??-??	54	54

TFL		HPL
1-1/8" Thick Standard TFL	1-1/8" Thick Premium TFL	1-1/8" Thick Standard HPL
2mm PVC	2mm PVC	2mm PVC
T1-A1	T2-A1	H1-A1
\$826	\$908	\$1,282
\$983	\$1,082	\$1,544
\$1,141	\$1,255	\$1,807

- TFL and HPL tops with 2mm PVC edges are only available with DeskMakers standard 2MM PVC edgebanding.
- Rounded corner will have a 4" radius.

loop leg conference table sets

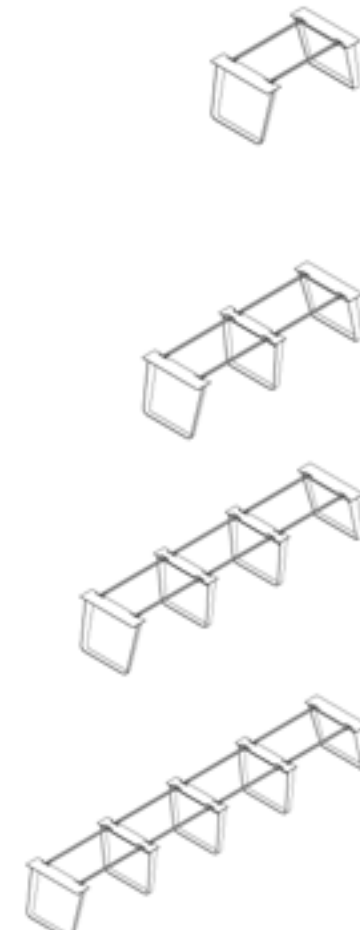

Model Number	Table Top Size	Base Size	Spanning Rod Length	Price
2 Bases & 2 Spanning Rods				
RB-ULG1-22-72-??	36 x 72	22	28	\$3,686
RB-ULG1-22-84-??	42 x 84	22	34	\$3,738
RB-ULG1-28-84-??	48 x 84	28	34	\$4,118
RB-ULG1-22-96-??	42 x 96	22	46	\$3,770
RB-ULG1-28-96-??	48 x 96	28	46	\$4,118
3 Bases & 4 Spanning Rods				
RB-ULG1-28-120-??	48 x 120	28	33	\$6,214
RB-ULG1-28-144-??	48 x 144	28	45	\$6,298
RB-ULG1-34-144-??	54 x 144, 60 x 144	34	45	\$6,298
4 Bases & 6 Spanning Rods				
RB-ULG1-28-168-??	48 x 168	28	37 3/8	\$8,390
RB-ULG1-34-168-??	54 x 168, 60 x 168	34	37 3/8	\$8,390
RB-ULG1-28-192-??	48 x 192	28	44 3/4	\$8,390
RB-ULG1-34-192-??	54 x 192, 60 x 192	34	44 3/4	\$8,480
5 Bases & 8 Spanning Rods				
RB-ULG1-28-216-??	48 x 216	28	37 5/8	\$10,598
RB-ULG1-34-216-??	54 x 216, 60 x 216	34	37 5/8	\$10,598
RB-ULG1-28-240-??	48 x 240	28	44 5/8	\$10,662
RB-ULG1-34-240-??	54 x 240, 60 x 240	34	44 5/8	\$10,662

- Includes leveling glides.
- Legs are constructed of solid steel frame with a powdercoat finish.
- Spanning rods are approximately 1" square steel with a powdercoat finish.
- Dimensions are nominal.
- To order, replace "???" with "SV" for silver. "BK" for black and "WT" for white finish.

hairpin leg set



Model Number	Max Table Top Size	Base Height	Legs Included	Price
RB-RPST-SET-??	48 x 96	28	4	\$3,576

- Includes leveling glides.
- Legs are constructed of solid steel frame with a powdercoat finish.
- Dimensions are nominal.
- To order, replace "???" with "SV" for silver. "BK" for black and "WT" for white finish.

power grommets

Power grommet and location applicability depends on the table size and the base specified. See the Conference Table Grommet Guide for information.

AC-DPGR-72

- (2) power outlets
- (2) 2.1A USB charging ports
- (1) convenience outlet on bottom
- (1) cutout for interface plate (not included)
- (2) RJ-45 keystone knock outs (jacks not included)
- (2) Cord Pass Throughs
- 144" long 15amp plug cord
- Finishes: Black, Silver, White and Brushed Aluminum



AC-DPGR-77

- (3) power outlets
- (1) convenience outlet on bottom
- (1) cutout for interface plate (not included)
- (2) 2.1A USB charging ports
- (2) RJ-45 keystone knock outs (jacks not included)
- 108" long 15amp plug cord
- Finishes: Black, Silver, White and Brushed Aluminum



Please see the electrical pricebook for additional information and pricing

AC-DPGR-74

- (6) power outlets
- (2) 2.1A USB charging ports
- (1) cutout for interface plate (not included)
- (2) 108" long 15amp plug cords
- Finishes: Black, Silver and Brushed Aluminum



AC-DPGR-78

- (3) power outlets
- (2) 2.1A USB charging ports
- (2) 45W USB C charging ports
- (1) RJ-45 keystone jack
- (1) HDMI port
- (1) open data port
- (2) 120" long 15amp plug cords
- Finishes: Silver and White



Please visit [Deskmakers.com](https://deskmakers.com) to view our current **Terms and Conditions**.

Please visit [Deskmakers.com](https://deskmakers.com) to view our current **Warranty**.

Showroom Locations

Los Angeles

Deskmakers Headquarters
6525 Flotilla Street
Commerce, CA 90040

San Francisco Bay Area

376 Martin Ave
Santa Clara, CA 95050

DeskMakers

Phone: 323.264.2260 | Fax: 323.725.6960
www.deskmakers.com